

\*\*\*\*\* Introducing the new ICS \*\*\*\*\*

**PILOT'S OPERATING HANDBOOK  
AND FAA APPROVED  
AIRPLANE FLIGHT MANUAL**

*"Formerly Published And Produced by the late Douglas L. Killough"*

Piper Aircraft ceased production of the Comanche and Twin Comanche in 1972, several years before the General Aviation Manufacturers Association (GAMA) established specifications for the contemporary Pilot's Operating Handbook (POH). As a result, the Owner's Handbook published by Piper is incomplete by modern standards. Now available **EXCLUSIVELY** from the **INTERNATIONAL COMANCHE SOCIETY, INC.**, through it's licensed agents, is the upgraded Pilot's Operating Handbook and FAA approved GAMA format Airplane Flight Manual.

Discounted to current ICS members at \$75.00 each plus shipping (must ask for ICS member discount and provide ICS membership number when placing order) Available **only through Webco Aircraft @ 316-283-7929 [www.webcoaircraft.com](http://www.webcoaircraft.com) \*Avail Bound or Unbound/Un-punched**

There are **SIXTEEN** different GAMA format manuals available for the Piper Single and Twin Comanche. Please order your manual by "Manual Number 1-16" from the attached chart.

**\*(Specify "Bound" or "Unbound/Un-punched")**

Order Qty Singles:	Manual Number	Model	Gross Weight	Year(s) Mfg	Flight Manual Report Number	SN Begin	SN End
	_____	01.)	180	2550	1957-64	1047	24-1
_____	02.)	250	2800	1958-60	997	103	2298
_____	03.)	250	2900	1961	1127	2299	2843
_____	04.)	250	2900	1962-64	1179	2844	3687
_____	05.)	250	2900	1962-64	1220 (FI)	2844	3687
_____	06.)	260	2900	1965	1334	4000	4299
_____	07.)	260	2900	1965	1333 (Carb)	4000	4299
_____	08.)	260B	3100	1966-68	1359	4300	4803
<b>Not Avail</b>	09.)	260B	3100	1966-68	1358 (Carb)	4300	4803
_____	10.)	260C	3200	1969-72	1545	4804	5028
_____	11.)	260T	3200	1970-72	1640 (Turbo)	4901	5028
_____	12.)	400	3600	1964-65	1295	26-3	148
<b>Twins:</b>							
	Manual Number	Model	Gross Weight	Year(s) Mfg	Flight Manual Report Number	SN Begin	SN End
_____	13.)	PA30	3600	1963-68	1269	30-2	1744
				1969	1515	1745	2000
_____	14.)	PA30T	3725	1964-68	1269 (Turbo)	143	1744
				1969	1515 (Turbo)	1745	2000
_____	15.)	PA39	3600	1970-72	1605	39-1	155
_____	16.)	PA39T	3725	1970-72	1605 (Turbo)	1	155



1134 N. Oliver Road, Hgr G \* Newton, Ks 67114 USA  
Ph. 316-283-7929 Fax 316-283-4702 Email: sales@webcoaircraft.com

**ELECTRICAL:**

- Light Weight Starter (8 lbs. lighter, cranks faster, no bendix to slick, STC'D)
- No more Hot Starts, 10.2 lbs total weight ..... \$ 775.00
- Battery Cable Kits Using M22759/16-2-9 Per MSB836A 180 & 250 (starter solenoid located top pilot side) \$210.00
- 180 / 250 / 260 (starter solenoid on bottom co-pilot side) ..... \$195.00
- 260B - \$130.00 / 260C - \$192.50 / PA30 - \$245.00 / 400 - \$210.00
- Starter Solenoid 487-149 (602-850) ..... \$115.00

**REPLACEMENT GASKETS:**

- Fuel cell gasket set PA24 (includes all 5 gaskets needed) ..... \$55.00/Tank
- Fuel cell gasket set PA30 (includes all 6 gaskets needed) ..... \$66.00/Tank
- Fuel door gasket W20327-003 \$6.35 PA30 Aux W19051-000 \$6.35
- 462-021 Fuel sender gasket . Call 751-871 Fuel Screen Gasket Call
- 462-014 Large oval cork Call 22846-000 Fuel filler PA30 Aux
- 20366-000 Blk oval (upper thin) 20366-002 Blk oval (lower)

**FUEL SYSTEM:**

- Fuel Bowl - W22034-00 (180/250/260) \$145.00 Drain valve 22179-00 Call
- Fuel screen combo W22458-000 (PA24 fuel bowl gasket w/screen) . . \$48.50
- Fuel screen strainer PA30 fuel valve ..... P.O.R.
- Fuel sender (transmitter) 20966-000 Main / 20966-002 Aux P.O.R.
- Fuel caps (WEBCO PMA'd) 180/250/260/ PA30 Main or PA30 Aux \$60.00
- Rubber replacements (fuel caps) (Main / Aux / Tip tank) \$19.25
- 12 volt Electric Fuel Boost Pump (Bendix/Facet style Carb. engines) \$678.00
- Fuel Selector wafer switch PA24 (W22843-000) . . . . \$195.50
- PA30 Fuel selector decal set \$15.00 PA24 Fuel selector decal set \$13.75
- PA24 or PA30 fuel selector dish (without decal) \$35.75
- Brand New Multi-Ply fuel cells Main & Aux. Call for \$\$\$

**GEAR & BRAKE MISC.**

- Strut seal kits (PA24 or PA24-400/PA30) (one per gear) . . . \$15.50
- Master Cylinder oring sets ..... \$1.95 to \$7.25
- Bungee Arms W20846-006 Left & W20846-007 Right (Heavy wall) \$325.00
- Bungee Cords (31322-007 or 8097) ..... \$29.50
- Main Gear door hinge W21065-012 ..... \$34.50
- Hub Cap / Wheel cover (round) . . . \$10.20 (raised) . . . \$32.25/\$26.80
- \* COMANCHE Bushings and Bolts - Give us a Call... We stock 'em ALL! \*

**ENGINE & EXHAUST MISC.**

- \*260 Heated Alternate air induction kit (STC'D) (AD 91-02-06) . . . \$850.00
- \* Turbo Rotary fuel pump metered fuel fitting (AD 91-08-07) . . . \$45.00
- W16559-000 Carb to airbox coupling boot (accordion style) . . . \$325.50
- Carb airbox- PA24 Repair Available.....Max \$750.00
- Airbox Repair Parts/Kits Available.....Call for Information
- Tach Cables (inner core only) PA24 PA30 . . . Call for Information
- Tailpipes 180/Call 250 PMA \$245.00 260 LH or RH Call Tailpipe clamp Call
- Oil Cooler Hose Kit 180/250/260 .. \$350-\$495 / PA30 (1 Kit / Eng) \$190.00
- Or send your hoses in for repair.
- Muffler shroud (PA24) W23489-000 \$489.50
- Carb Heat Shroud -Lower 180 PMA...\$104.50 Others avail upon request
- Baffle rubber kit - 180/250/260/PA30 ..... \$49.50
- Felt for baffles . . . . . \$49.50 Rubber AND felt kit \$94.50
- Vernier Throttle Kit (Black) w/switch.....Call for other engine cable options
- Prop Governor Cable.....Call for other engine cable options
- Mixture Control Cable.....Call for engine other cable options
- (\* All 3 above cables require 337 field approval)
- Vernier Control Cable-112"-FAA-PMA'D.....\$228.50
- All Control Cables for PA30 (Push/Pull) . . . Call for Price & Availability
- Don't forget to ask about our nacelle auxiliary tanks for PA30/PA39**

**DOOR:**

- Upper Door latch kit (STC'd - Cherokee style) ..... \$785.00
- Lower hinge area repair kit (brace/reinforcement) ..... Call for Info
- Holder (catch) repair kit (spring & rollers for door holder) \$18.00
- Cabin Door Seal - Regular(&PA24 co-pilot side baggage doors) \$5.95/Ft
- Baggage Dr Seal PA24 Pilot side & all PA30 (23183-000) 10' len \$73.10/44.85
- Plus Inner Cord (for the 23183-000).....187-652 (8' len) \$3.00/Ft
- Door Lock mechanism (Reg) \$16.50 or (Tubular Cam). \$26.85
- Interior handle Piper \$90.00 or \*\*\* Call for options

**WINDOWS:**

- 1/4" STC'd Complete Set - 4 place (less windshield) Call.....Call
- 1/4" STC'd Complete Set - 6 place (less windshield) Call.....Call
- Windshield 1/4" 1 PC (FOB factory) Call.....Call
- Windshield 1/4" 2 PC (FOB factory) (each) Call.....Call
- Caulking/Sealant for windows/windshield (per tube) ..... \$5.00

**MISC:**

- Make all your orders easy. Complete PARTS or SERVICE manuals
- Parts/Service PA24 Parts/PA30 Parts...\$58.50 PA30/39 Service \$70.00
- Aileron Bulkhead Kit (763-893) \$1923.40
- Hinge Bracket kit (760-914) Call
- PA30 Rudder Tip \$238.90 PA30 Beacon Fairing \$?
- Stabilator tip PA24 or PA30 - Plastic Call Fiberglass \$187.50 / \$160.00
- Tail Cone Fairing (Fiberglass) \$132.00
- Wing root seal Upper set (2 wings) \$92.70 Lower set (2 wings) \$44.50
- Wing tip mirrors (visually check gear down) Call for Info
- Nav Light reflectors (visually check your nav lites) RH or LH Call for Info
- Landing Light Lenses W20348-000 LH & W20348-001 RH (LEXANI) \$43.50
- Trim Seal (J Channel) \$2.25 per foot
- Cowl Chafe Cotton seal strip ...Starting at \$1.00/FT various widths
- Canvas Nose wheel cover PA30 23956-000 Call for info
- Wheel well liner/cover PA30 or PA24 (LH or RH) Call
- PA30 Nose bowl hinges - Hinge pin upper or lower Call-Repair Parts Available
- Cowl support rod (PA24) Call for Info
- Heated Pitot Tube Call for Info Pitot tube mounting mast Call for Info
- Rubber steering rod boot 21378-000 \$50.00
- NEW SKIN STOCK AND BULKHEAD BLANKS
- Flap, Aileron, Rudder, Stabilator, Fuselage and Wings. Most Available.**

**CALL.**

**ACCESSORY REPAIR/EXCHANGE**

- Gear Transmission / Flap Transmission
- Call for Current Options
- Fuel Selector Valves
- PA30 - (Airborne 1H7 Series) repair base price \$450.00
- (New Strainer screen Market Price)
- New brass valve for Experimental
- Hoof valve repair available -Starting at \$300
- PA30 Heater regulator valve (exchange) \$CALL\$
- Weldon Boost Pumps (injected, PA30 ONLY) \$CALL\$
- Generator Exchange 50Amp Delco-Call for availability
- 70 AMP Stc'd Alternator Kit
- Single.....SAL12-70.....\$1885.00
- Twin.....TAL12-70.....\$3628.00
- Now**
- Now Stocking PMA'D PA24-180/250/260
- Lower Cowl Scoops

All Prices Are Subject to Change Without Notice. Check with us for all your Comanche Needs.

## Main Gear Misc.

**Link Rod**  
20768-000 LH 180/250  
20768-001 RH 180/250  
24911-000 (260 & 260B)  
22577-000 (400/30 sn 2-694)  
25046-000 (260C/PA30 695/UP)  
P.O.R.

**Rod End Bearing**  
W23412-000  
180/250/260A&B  
Call  
W22943-000  
(260C/400/PA30)  
Call

**Bolt**  
400-313  
(180/250/260A&B)  
\$9.65 Ea.  
400-368  
(260C/400/PA30)  
\$9.90 Ea.

**Spherical Bearing**  
452-367  
Generic \$56.72 Ea.  
(180/250/260A&B)  
751-454  
(260C/400/PA30)  
\$124.68 Ea.

**Bolt 400-016**  
\$1.50 Ea.  
**Bushings**  
14843-069 (Long)  
\$55.00 Ea.  
14843-079  
(Short)  
\$22.95 Ea.

**Bungee Cord**  
31322-007  
(8097)  
(All Models)  
\$29.50 Ea.

**Spring**  
83302-040  
\$48.00 Ea.

**Bushing**  
20737-008  
\$123.00 Ea.  
per link assy  
4 per A/C

**Bolt**  
400-761  
\$11.75 Ea.

**Bushing**  
W20737-006  
(180/250)  
W20737-014  
(260/400/PA30)  
\$40.00 Ea.

**Shims**  
14843-020  
(.125" thick)  
14843-093  
(.062" thick)  
19513-010  
(.035" thick)  
Call for Info

**Bushing**  
W14843-030  
\$26.75 Ea.

**Bushing**  
W20737-005  
(180/250)  
W20737-013  
(260/400/  
PA30)  
\$40.00 Ea.

**Bolt**  
401-346  
(5 & 1/16")  
\$14.50 Ea.  
401-347  
(5 & 3/16")  
\$12.50 Ea.

**Bungee Arm**  
Thick Wall  
W20846-006 LH  
W20846-007 RH  
\$285.00 Ea.

**Bushing**  
14843-060  
\$75.95 Ea.  
**Bolt**  
400-757  
\$11.50 Ea.

**Bushing**  
14843-016  
\$14.75 Ea.  
(4 per link assy)  
(8 per A/C)

**Stud**  
W20829-000 (180/250)  
\$185.00 Ea. Piper \$405.00  
W22512-000 260/400/30)  
\$185.00 Ea. Piper \$308.50

**PA24 Owners:**  
Be aware that crack-  
ing is common on the  
thin wall bungee arms.

**Bushing**  
14175-050  
\$26.50

## Gear Door Misc.

**Bracket**  
21320-006  
Fore/Front  
21322-006  
Fore/Rear  
Call for Info

**Clevis**  
454-901  
\$26.95 Ea.

**Eye-Bolt**  
402-032  
\$12.10 Ea.

**Bracket**  
21320-007  
Aft/Rear  
21322-007  
Aft/Front  
Call for Info

**Hinge**  
W21065-012  
\$34.50 Ea.

**Bracket**  
21068-00 LH/001 RH (180/250)  
24842-00 LH/001 RH (260A/B)  
24819-000 LH/001 RH  
(260C/400/PA30 695 & UP)  
22825-000 LH/001 RH (30 1-694)  
Call for Info

**Bushing**  
W80012-097  
\$10.00 Ea. or  
80012-006  
\$25.00 Ea

**Hinge**  
W21318-000  
\$45.00 Ea.

**Door**  
21112-000  
Call for Info

**Rod End**  
W452-383 \$18.50  
CA452860A \$54.00  
Call for Info

**Rod Assy**  
Complete  
W21067-003  
\$89.50 Ea.

**Bushing**  
14976-009  
\$28.00 Ea.

**Horn**  
21317-000  
Call for Info

**Spring Washer**  
408-833  
\$10.60 Ea.

**Horn**  
21066-000  
Call for Info

**Rod Assy**  
Complete  
21118-003  
Call for Info

**Gear Door**  
LH 22984-000  
RH 22984-001  
Call for Info

**260C & PA30**  
Nose Gear  
Doors  
Repair Parts  
Available  
Call for Info

**Bumper**  
Gear Door  
453-887 Thin  
\$7.25 Ea  
453-646 Thick  
\$3.00 Ea



All Prices Are Subject to Change Without Notice

## Nose Gear Misc.

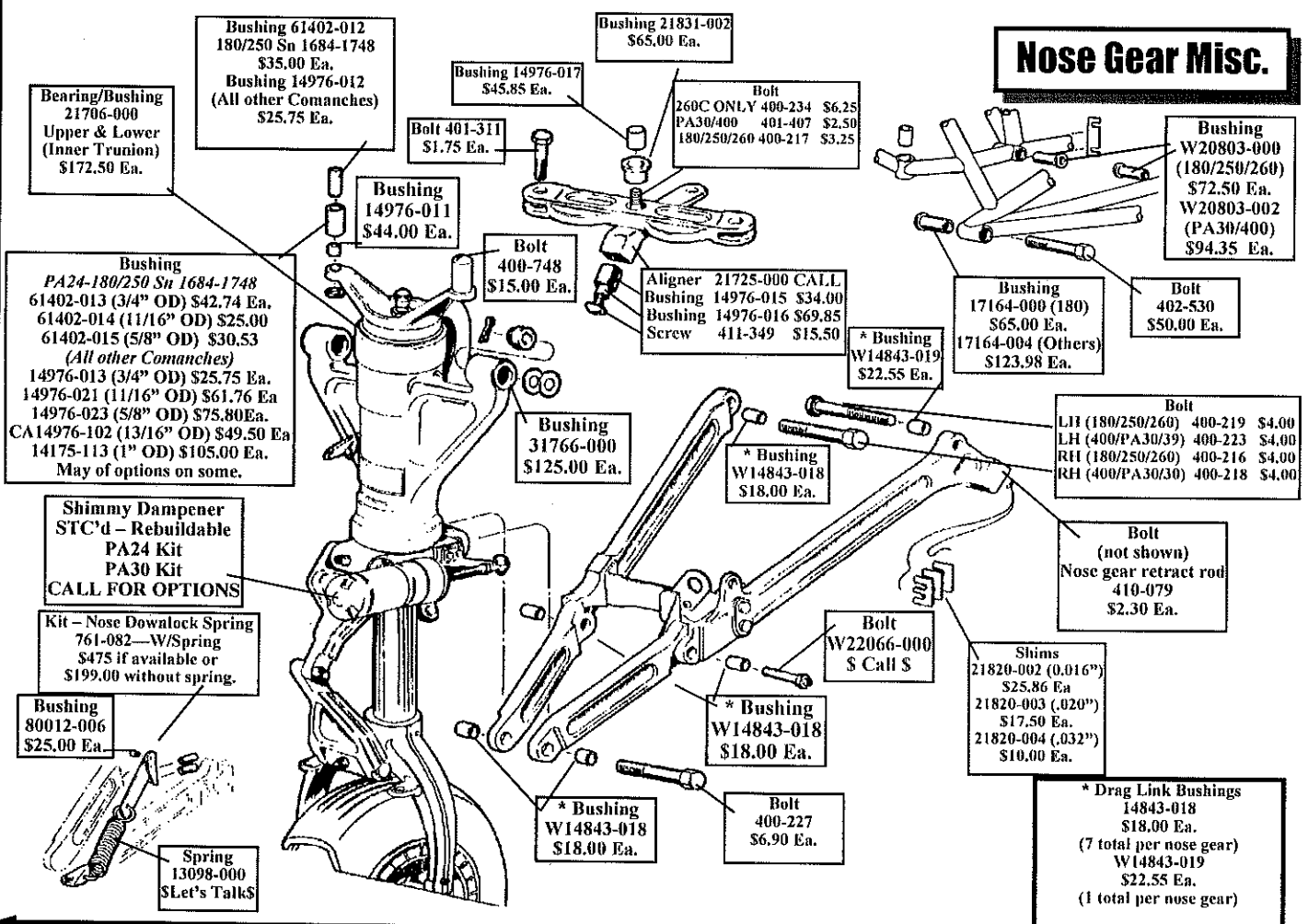

## Strut Misc.

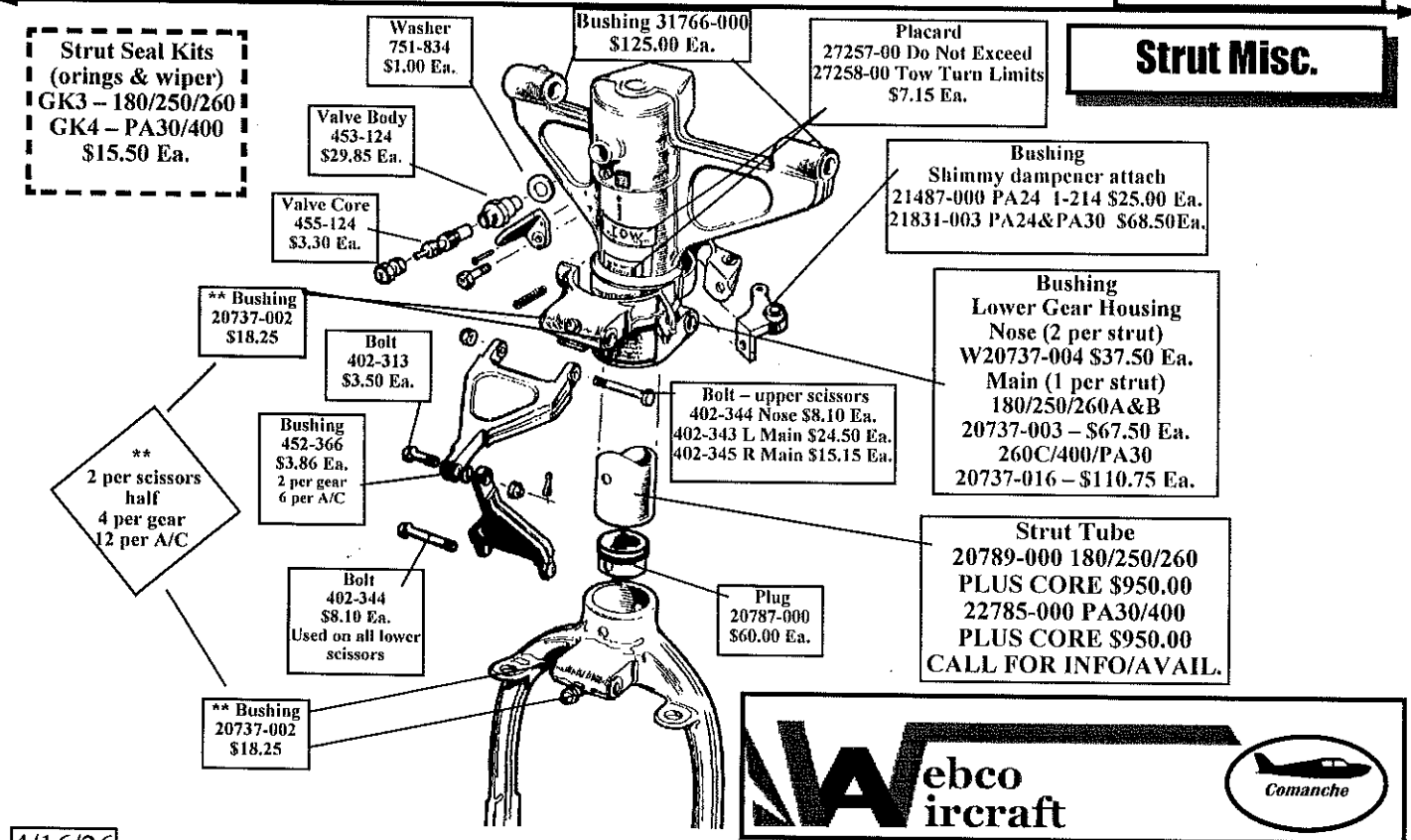

4/16/26

All Prices Are Subject to Change Without Notice

**AVAILABLE SOON !! \*\*\***  
**ALL NEW - FAA-PMA'd**  
**Comanche Gear Push-Pull Conduits**  
**P/N W455-180**  
**Featuring:**  
**All New Design**  
**Stainless Steel Construction**  
**Closed Seal System**  
**Teflon Inner-Lined**  
**No Lubrication Needed**  
**Less Load on Transmission Assy**  
**\$ TBA \*\*\***  
**Piper's \$1390.08 Ea.**

**Gear System Misc.**

**Spring**  
 Gear Trans. Emergency Release  
 83302-039  
 (PA24 SN 1-3557)  
 Call for information  
 83302-031  
 (All Other Comanches)  
 Call for information

**Clevis Stud**  
 Nose Gear Drag Link  
 20859-003  
 (PA24-180/250)  
 Call for availability  
 23103-000  
 (All Other Comanches)  
 Call for availability

**Camloc Stud**  
 Gear Access Door  
 (Folding)  
 487-668  
 Call for Availability

**DRESS UP YOUR INTERIOR!**  
**PLATE**  
 Gear Lever  
 Boot Attach  
 W21207-000  
 \$ 38.50

**Gear Lever Boot**  
 Replacement  
 21280-000  
 Call for options

**Tube - Inner**  
 Nose Gear Trunion  
 21707-000  
 Call for Repair Options

**Rod End Bearing**  
 Nose Gear Rod  
 452-356  
 (PA24 180/250 SN 1-3530)  
 Can use  
 CA452-412  
 (All Other Comanches)  
 \$68.50 Ea. (NLA)  
 \$60.00 Ea.

**Drag Links**  
 Nose Gear  
 20814-000 LH Front  
 20815-000 RH Front  
 20819-000 RH Rear  
 20817-000 LH Rear  
 (180/250 SN 1-3225)  
 23109-000 LH REAR  
 (all other Comanches)  
 Used/As Removed  
 Call for Price & Availability

**Nut**  
 Gear Conduit  
 21063-000  
 Only used available

**Rod End Bearing**  
 Gear Conduit  
 452-377  
 \$382.00 Ea.

**Gear Transmission / Motor**  
 Repairs: call for options

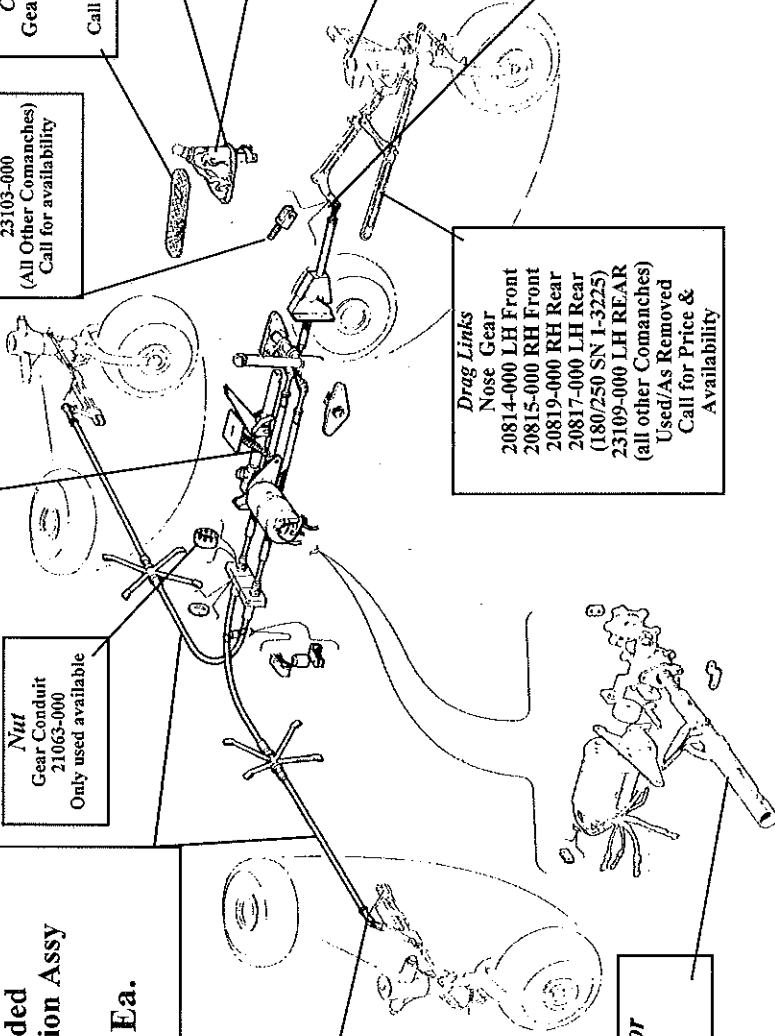

**KEEP YOUR GEAR UP TO SPEED**  
 We stock all Comanche Gear Parts Including:  
**BUSHINGS / BOLTS**  
**BEARINGS / ROD ENDS**  
**LINKS / STUDS**  
**CIRCUIT BREAKERS / SWITCHES**  
**WIRING HARNESSSES**  
**SOLENOIDS / SPRINGS**  
**GIVE US A CALL!**

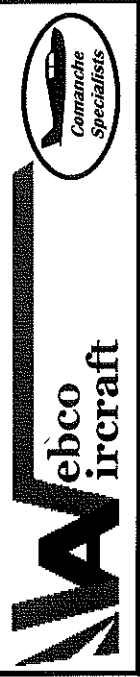

*All Prices Are Subject to Change Without Notice*

11/21/25 \*Prices subject to change



1134 N. Oliver Road, Hgr G \* Newton, Ks 67114 USA  
Ph. 316-283-7929 Fax 316-283-4702 Email: Sales@webcoaircraft.com

**SOON AVAILABLE!! \*\*\***  
**ALL NEW - FAA-PMA'd**  
**Comanche Gear Push-Pull Conduits**  
**W455-180**

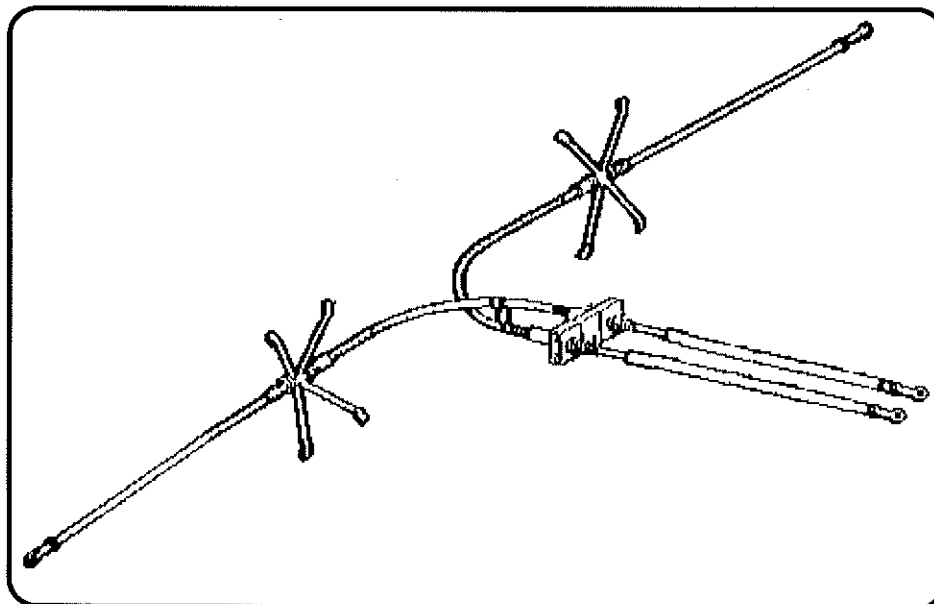

**Featuring:**  
**All New Design**  
**Stainless Steel Construction**  
**Closed Seal System**  
**Teflon Inner-Lined**  
**No Lubrication Needed**  
**Less Load on Transmission Assy**  
**TBA \*\*\***  
**Piper's \$1390.08 Ea**

# Tail Section Misc.

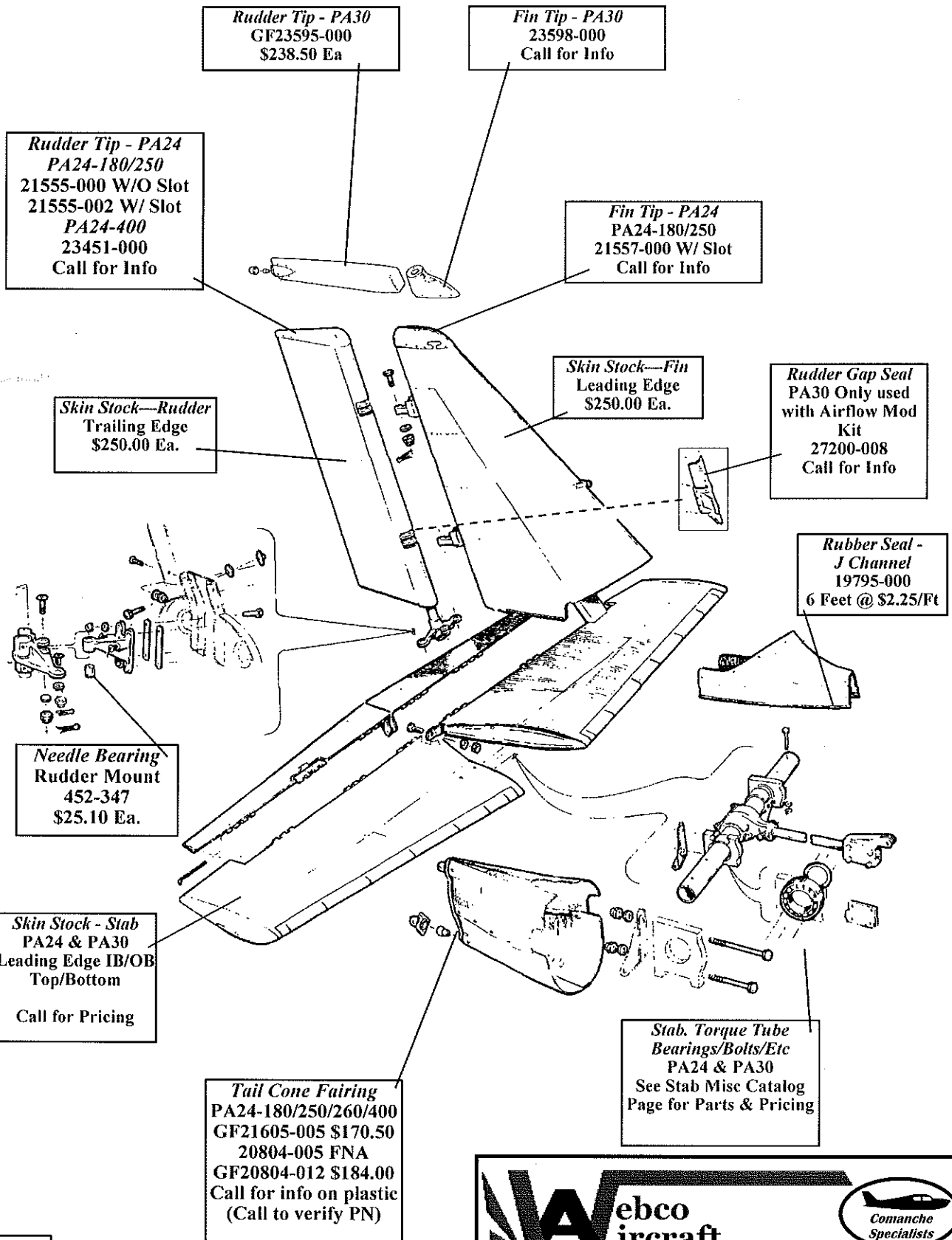

**Rudder Tip - PA30**  
GF23595-000  
\$238.50 Ea

**Fin Tip - PA30**  
23598-000  
Call for Info

**Rudder Tip - PA24**  
PA24-180/250  
21555-000 W/O Slot  
21555-002 W/ Slot  
PA24-400  
23451-000  
Call for Info

**Fin Tip - PA24**  
PA24-180/250  
21557-000 W/ Slot  
Call for Info

**Skin Stock—Rudder**  
Trailing Edge  
\$250.00 Ea.

**Skin Stock—Fin**  
Leading Edge  
\$250.00 Ea.

**Rudder Gap Seal**  
PA30 Only used  
with Airflow Mod  
Kit  
27200-008  
Call for Info

**Rubber Seal -  
J Channel**  
19795-000  
6 Feet @ \$2.25/Ft

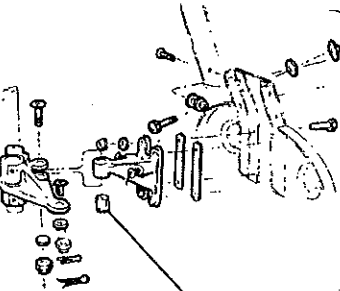

**Needle Bearing  
Rudder Mount**  
452-347  
\$25.10 Ea.

**Skin Stock - Stab**  
PA24 & PA30  
Leading Edge IB/OB  
Top/Bottom  
Call for Pricing

**Stab. Torque Tube**  
Bearings/Bolts/Etc  
PA24 & PA30  
See Stab Misc Catalog  
Page for Parts & Pricing

**Tail Cone Fairing**  
PA24-180/250/260/400  
GF21605-005 \$170.50  
20804-005 FNA  
GF20804-012 \$184.00  
Call for info on plastic  
(Call to verify PN)

11/21/25

**Webco Aircraft**  
Comanche Specialists

All Prices Are Subject to Change Without Notice

## Stabilator Misc.

**Bolt**  
 502-329 AN174C32A \$34.50 Ea.  
 180/250/260  
 (4 per A/C)  
 502-342 AN175C32A \$32.50 Ea.  
 PA30/400

**Bolt**  
 400-932 (AN24-46A) \$18.75 Ea.  
 All Models  
 (2 per A/C)

**Bolt**  
 691-352 \* (NAS6604-29) \$4.50 Ea.  
 All Models  
 (1 per A/C)  
 \* Replaces 402-321

**Bolt**  
 502-343 (AN175C33A) \$32.50 Ea.  
 All Models  
 (2 per A/C)

**Bearing**  
 W452-363 \$285.00 Ea.\*  
 All Models  
 (2 per A/C)

**Bolt - Lower**  
 401-380 AN5-54A \$19.85 Ea.  
 180/250/260  
 (2 per A/C)  
 401-382 AN5-56A \$18.85 Ea.  
 PA30/400

**Bolt - Upper**  
 401-383 AN5-62A \$ CALL \$  
 180/250/260  
 (2 per A/C)  
 401-384 AN5-63A \$25.00 Ea.  
 PA30/400

**Hinge Half (Tab side)**  
 20194-018 16914-000  
 (180/250/260)  
 (PA30/400)  
 Call for Info

**Hinge Half (Stab side)**  
 20193-028  
 (180/250/260/30)  
 Call for Info  
 16194-000  
 (400)  
 Call for Info

**Hinge Pin**  
 21510-000  
 21510-002  
 Call for Info  
 (6 per A/C)

**Stab Tip Block \***  
 20257-002  
 (Front, all but 400)  
 20257-003  
 (Rear, all but 400)

**Stab Screw \***  
 415-289 Rear  
 415-292 Front  
 \$2.75 Ea.

**Stab Tip**  
 180/250/260 Early PA30  
 21556-000 Plastic Call  
 21556-000F Fiberglass \$198.00  
 Late PA30 / 39  
 25066-000 Plastic Call  
 25066-000F Fiberglass \$185.00

\* Parts are different for PA24's with Stab Weight Mod kit installed.

11/21/25



All Prices Are Subject to Change Without Notice

## Stab Trim Misc.

## Rudder Pedal Misc.

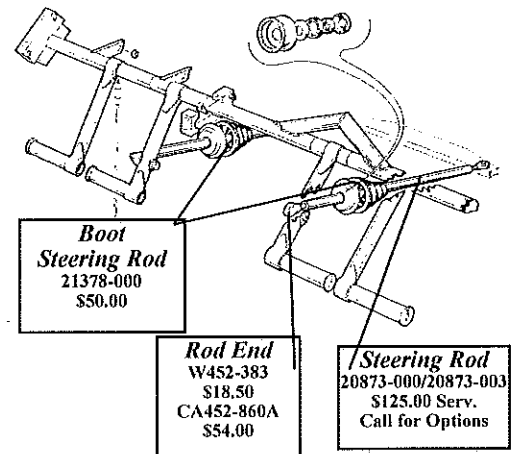
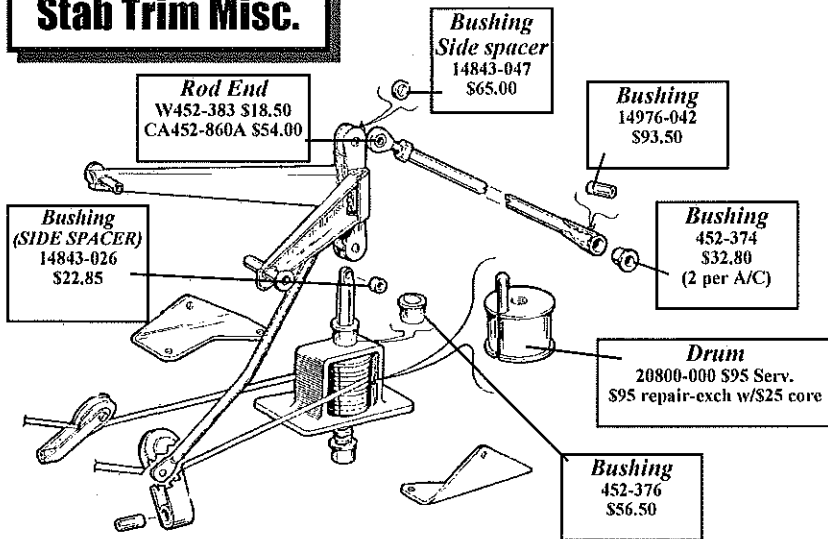

## Elec. Flap Misc.

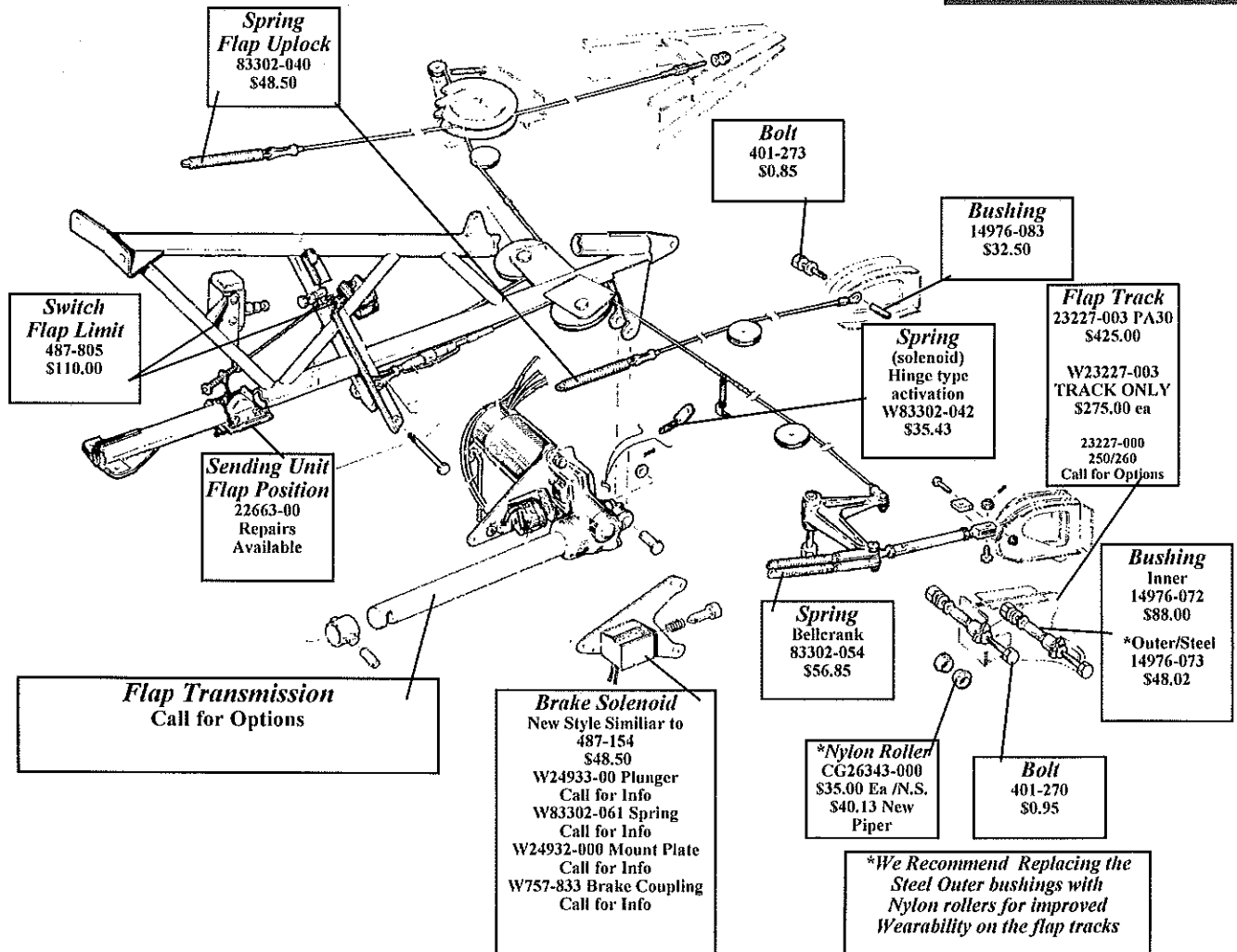

11/21/25

**Webco**  
**ircraft**



All Prices Are Subject to Change Without Notice

## Fuel System Misc.

**CamLoc Stud**  
 487-590 W/SS (2600-5SW) \$12.75  
 487-692 W/SS (2600-8SW) \$12.50  
 Stainless, Wing Head  
 487-590 S/SS (2600-5S)  
 Stainless, Slot Head  
 \$11.85 Ea.  
 494-060 Star Lock Washer  
 \$0.68 Ea.

**Fuel Door Gasket**  
 Call for Info  
 20327-003  
 PA24 Main/Aux / PA30 Main  
 19051-000  
 PA30 Aux / PA24-400 Aux  
 Call for Info

**Fuel Transmitters**  
 20966-000 All Main Tanks  
 20966-002 All Aux Tanks  
 Repairs Available  
 751-884 Tip Tanks  
 P.O.R.  
 494-063 Sender Washer  
 \$0.78 Ea.  
 751-767 Sender Float  
 \$14.00 Ea.  
 462-021 Sender Gasket  
 Call for Info

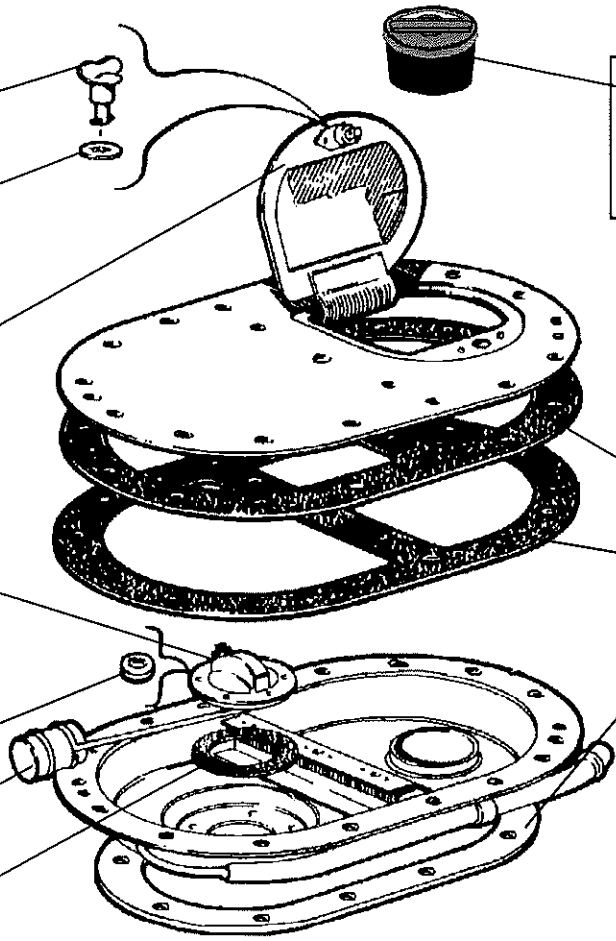

**Webco PMA'd Fuel Caps**  
 \$60.00 Ea.  
 (keep water out and fuel in)  
 WFC1 - PA24 Main & Aux, PA30 Main  
 PA30 Aux, PA24-400 Aux  
 Piper Style (Flip handle) \$139.50

**Fuel Door Lock**  
 DL5  
 \$16.50 Ea.  
 (similar to Cabin/Baggage door locks)  
 Tubular style  
 DL5T  
 \$27.50 Ea.

**Fuel Cell Gaskets**  
 20366-000 Upper, Thin  
 20366-002 Lower, Thick  
 462-014 Oval, Cork  
 22846-000 PA30 Aux  
 Call for Info  
**Gasket Set**  
 PA24 Main/Aux, PA30 Main  
 (includes 5 gaskets)  
 \$55.00 Per Tank

PA30 Aux  
 (includes 6 gaskets)  
 \$66.00 Per Tank  
 PA24-400 Aux  
 (includes 12 gaskets)  
 \$137.50 Per Tank

**Fuel Strainer Assy**  
 PA24 SN 24-2299 & Up  
 Clamp Assy  
 22306-000  
 P.O.R.  
 Snap Ring  
 484-728  
 \$8.00 Ea.  
 Fuel Strainer Screen  
 W22458-000  
 \$48.50  
 Fuel Sump Bowl  
 W22034-000  
 \$145.00  
 Drain Valve Assy  
 22179-000 Type  
 \$26.80

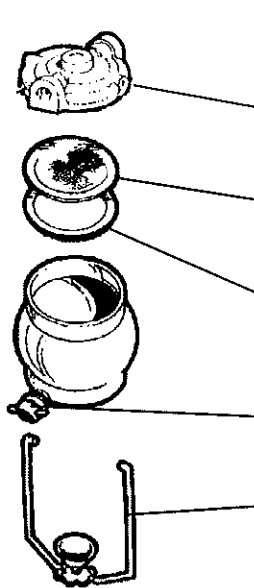
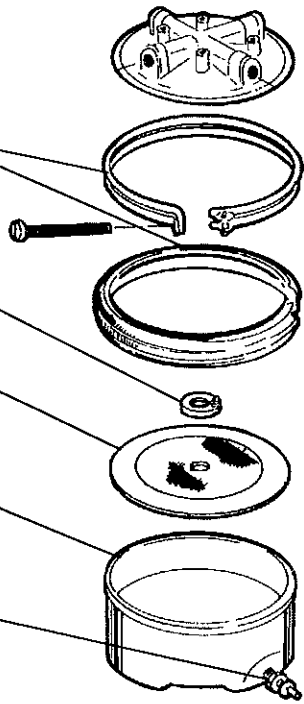

**Fuel Strainer Assy**  
 PA24 SN 24-1 To 2298  
 Cover Assy  
 14428-000  
 \$130.00 Ea.  
WHEN AVAILABLE  
 Fuel Strainer Screen  
 750-272  
 \$4.95 Ea.  
 Fuel Strainer Gasket  
 85012-032  
 \$4.95 Ea.  
 Drain Valve Assy  
 CCA1550/492-022  
 \$22.50 Ea.  
 SEAL ONLY \$8.85  
 Wire Assy (Bail)  
 494-644  
 Call for Info



11/21/25

All Prices Are Subject to Change Without Notice

# Intake & Exhaust Misc.

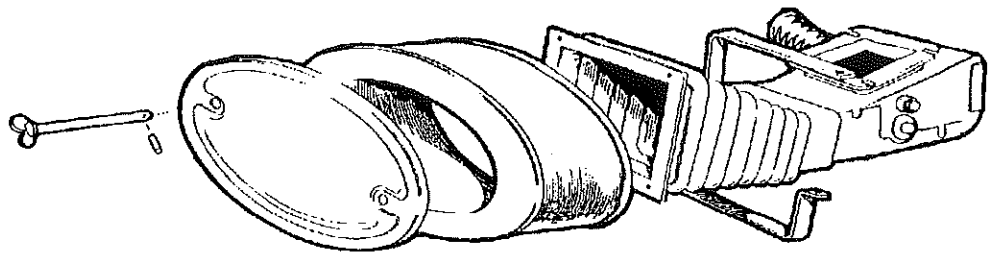

<b>Stud</b> 487-616 Call for Info	<b>Pin</b> 480-650 \$1.50	<b>Air Filter Cover</b> 16553-002 \$150.00	<b>Air Filter Assy</b> BA104 \$44.95 BA3 \$24.98	<b>Coupling Boot</b> W16559-000 \$325.00	<b>Airbox Assy</b> 21943-003 Call for Info
---	---------------------------------	--	---	--	--

Bushing & Shaft Repair Kit for ABOVE airbox – WAB3  
 Butterfly flapper valve replacement for ABOVE airbox – WAB4  
 (Brackett air filters and elements available for all other Comanches except 400)  
 Bushing & Shaft repair kit for EARLY 250 airbox – WAB5  
 Butterfly flapper valve replacement for EARLY 250 airbox – WAB6  
 Bushing & Shaft repair kit for EARLY 180 airbox – WAB1  
 Butterfly flapper valve replacement for EARLY 180 airbox – WAB2  
 \* Call for Information

**Muffler Shroud (without plenum)**  
 180 – SN 1 to 102  
 W23503-000  
 Call for Repair Options

180/250 SN 103-2298  
 W23504-000  
 Call for Repair Options

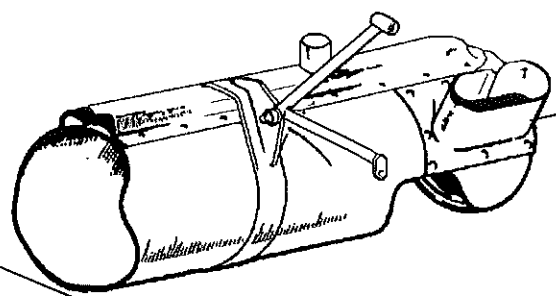

**Muffler Shroud (with plenum)**  
 SN's 2299 & Up  
 180 – W23507-000  
 Call for Repair Options

250 – W23489-000  
 \$489.50

**Muffler Clamp**  
 180/250 (2 9/16")  
 W14235-008  
 (some 180's use 2 1/16")  
 W14235-000  
 Call for Info

**Shroud Clip**  
 W21247-000  
 \$45.00

**Tailpipe Clamp**  
 W21167-000  
 Call for Info

**Tailpipe**  
 180 – W21580-002  
 Call for Info  
 250 – W21580-000  
 \$245.00

We also offer  
 Exhaust gaskets.

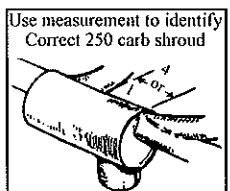

**Carb Heat Shroud**

180 Lower – W21165-003 \$265.00	250 Lower – W24473-000 Call for Options
180 Upper – W21165-002 (SN 1-2298 w/90 deg takeoff)	250 Upper – W24472-002 (with 1 7/8" measurement)
180 Upper – W22093-000 (SN 2299/Up w/45 deg takeoff)	250 Upper – W24542-000 (with 4 1/4" measurement)

\*Call for options



09/11/25

All Prices Are Subject to Change Without Notice

**Cabin Door Misc.**

**WDL1**  
**Upper Door Latch Kit - \$765.00**  
 (8-12 Hours, Avg. Installation)

**DS3**  
**Cabin Door Seal**  
 Regular or Hollow  
**\$6.50 per foot**  
 11 FT REQUIRED  
 MITRE LOWER CORNERS

**1/4" Side Window Sets**  
**Clear    Bronze/Gray**  
 4 Place **\$1000.00    \$950.00\***  
 6 Place **\$1260.00    \$1200.00\***  
 (14-18 Hours Avg. installation time-Clean up  
 Prep takes the longest)  
 \*Green Tint available at extra  
 charge  
 Set includes frameless vent in Pilots  
 window.  
 (frameless vent in Co-Pilot window  
 available at extra cost)

**464-022**  
**Door Handle**  
**\$90.00 / Piper**  
 \*Call for options\*

**DK2**  
**Reinforcement Brace**  
 (Lower door hinge area)  
**\$82.50**  
**Repair Part**  
 (2-4 hours avg. install time)

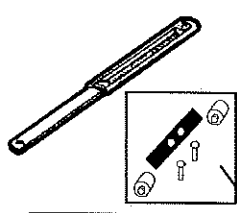

**WDK1 - Holder Repair Kit**  
 (spring, rivets, rollers / repair your existing holder)  
**\$18.00**  
**Webco Now Stocks the Door Steward**  
 Pneumatic Door Holder STC'd Kit at \$290.00

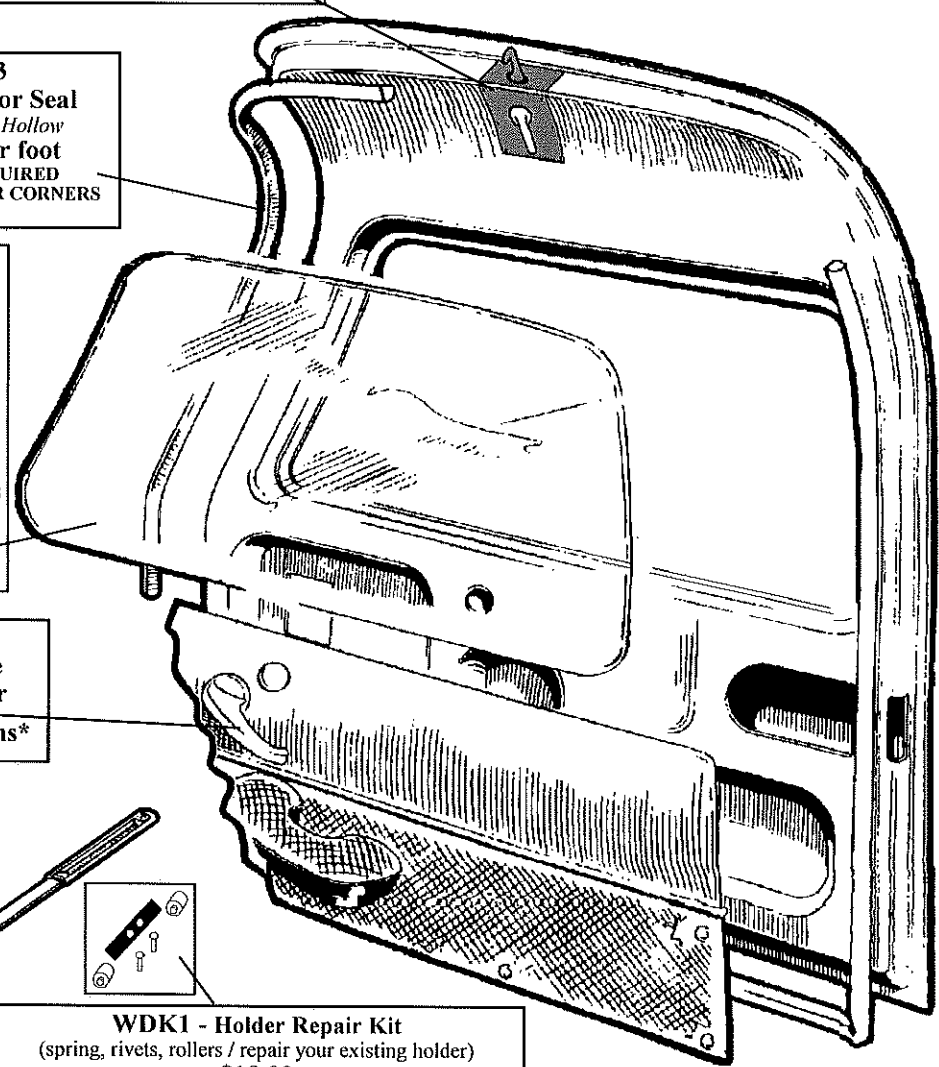

**Baggage Door Misc.**

**Baggage Door Seal**  
 (PA24 w/Door on Co-Pilot Side)  
 (same as cabin door seal)  
**\$6.50 per Foot**  
 (7 feet required)  
 (PA24 Pilot Side Door)  
 (PA30 All baggage Doors)  
**\$73.10 or \$46.50**  
**per 10' Len**  
 (PN 23183-000)  
 Inner cord (8ft) \$24.00

**DL4 / DL5 Door Lock**  
**\$16.50**  
**DL5T**  
**Tubular Door Lock**  
**\$27.50**  
 (May be ordered keyed alike  
 for use on both doors)

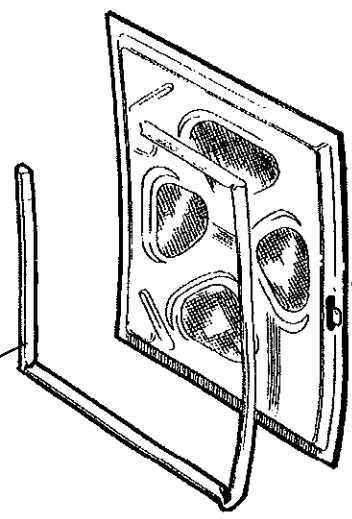

11/21/25

All Prices Are Subject to Change Without Notice



1134 N. Oliver Road, Hgr G \* Newton, Ks 67114 USA  
Ph. 316-283-7929 Fax 316-283-4702 Email: sales@webcoaircraft.com

---

Distributors of  
**Brand New**  
**Comanche Fuel Cells**

**FAA-PMA Approved**  
**Tested MULTI-PLY Construction**

**We have both Main & Aux**

**180/250 Early Main \$1295.00**

**250/260 Later 400 / PA30 Main \$1325.00**

**250/260 Aux \$1260.00**

**PA30 Aux \$1275.00**

**Call for options on 400 Aux**

---

**Fuel cell gasket set PA24 (includes all 5 gaskets needed)....\$55.00/Tank**

**\*DISCOUNTED WITH FUEL CELL PURCHASE**

**Fuel cell gasket set PA30 (includes all 6 gaskets needed)....\$66.00/Tank**

**\*DISCOUNTED WITH FUEL CELL PURCHASE**

**Fuel Door Gasket....20327-003....Call for Information**

**PA30 Aux 19051-000.....Call for Information**

**462-021 Fuel Sender Gasket.....Call for Information**

**751-871 Fuel Screen Gasket.....Call for Information**

**462-014 Large Oval Cork.....Call for Information**

**22846-000 Fuel Filler PA30 Aux...Call for Information**

**20366-000 Black Oval (upper).....Call for Information**

**20366-002 Black Oval (lower)... Call for Information**

---

*All Prices Are Subject to Change Without Notice. Check with us for all your Comanche Needs.*

06/05/25



1134 N. Oliver Road, Hgr G \* Newton, Ks 67114 USA  
Ph. 316-283-7929 Fax 316-283-4702 Email: Sales@webcoaircraft.com

---

## Gap Seal Kits

FAA-STC'D  
BEST FIT  
EASIEST INSTALLATION  
BEST QUALITY  
EXCLUSIVE BAKED-ON TEFLON COATING  
ONLY \$680.00 Per Kit

---

## NACELLE FUEL TANK KITS

Mounts in center  
nacelle bay on  
each side.

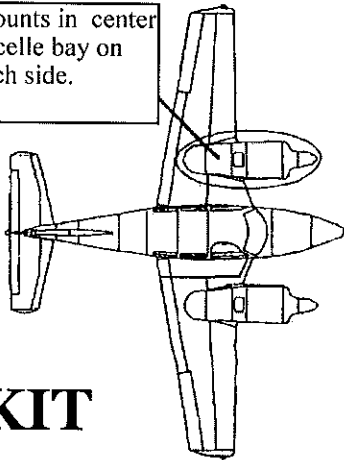

KIT

FAA-STC'D  
FEATURES:  
EASY INSTALLATION  
10.2 GAL/SIDE, ALL USEABLE  
ALL ENCLOSED PLUMBING  
\$3500.00 COMPLETE

---

## Side Window Sets

FAA-STC'D  
BEST FIT  
HIGHEST QUALITY  
EASIEST INSTALLATION  
BEST QUALITY  
BEST VALUE AVAILABLE  
PRICES START AT \$950.00 Per Set

---

*All Prices Are Subject to Change Without Notice. Check with us for all your Comanche Needs.*

01/07/25

**ELECTRICAL COMPONENTS:**

We stock most all Comanche Electrical Parts Including:

- Landing Light Bulbs
- Circuit Breakers
- Flap/Gear Switches
- Rheostats\*\*
- Panel Switches
- Bulbs
- Cables
- Solenoids

GIVE US A CALL!

**Upper Console**

21309-00  
24705-00  
26637-004  
LENSES:  
20635-002/003  
Call for Information  
SPEAKER:  
21879-000 - \$50.00 Ea.

**Electrical Misc.**

**Rotating Beacon**

Assy - WRML-14R  
\$CALLS  
Lens - 754-527  
Bulb - 1940  
\$13.60  
WRM1940 \$26.95

**Pilot Tube**

Must - 21299-000  
Call for Information  
Tube - 21301-000  
Market Price

**Lift Detector**

450-742  
Call  
\$725.20

**Gear Warning Horn**

\$65-\$25  
Call for Availability

**Tail Nav Light**

Bulb  
GE93 - 180/250  
\$3.00  
GE1073 - 260/400/30  
\$3.50  
LENS - 751-203  
\$42.85

**Cable w/Bolt Positive**

14069-000 \$83.70  
Alt 66616-000 \$68.50

**Clamp**

454-925  
\$28.00  
Tubing  
\$4.00/Ft.

**Starter Solenoids**

487-149 - 602-850  
All PA24/P A30 up to 1744  
Piper - \$128.50  
487-163  
PA30 1745 & UP \$68.75

**Gear/Flap Solenoids**

487-152 - 584-420  
All Models  
\$165.00  
PMA'D Alternates \$115.00

**Master Solenoid**

455-342  
All PA24  
\$365.50 Ea.  
455-151  
PA30/39  
\$350.00  
PMA'D Alternates \$115.00

**Battery Cable Kits**

Mil Spec #2 Gauge Copper  
180/250 solenoid top pilot  
\$210.00  
180/250/260 solenoid bottom co-pilot  
\$210.00  
260B - \$155.50  
260C - \$192.50  
PA30 (Front/Rear Battery)  
250.00

**Nose Gear Switch**

487-820  
NOSE GEAR DOWNLOCK  
180/250/400 PA30 up to 694  
\$185.00 Ea.  
487-862  
NOSE GEAR DOWNLOCK  
ALL 260 - PA30 695 & UP  
\$525.00 Ea.

**Gear Switch**

487-820  
SAFETY/SQUAT - 180/250/400 PA30 up to 694  
L&R DOWNLOCK - 180/250/400 PA30 up to 694  
\$185.00 Ea.  
487-864  
L&R DOWNLOCK/SAFETY/SQUAT - 260 ALL  
RH DOWNLOCK ONLY - PA30 695 & UP  
\$725.50 Ea.  
487-863  
LH DOWNLOCK/SAFETY/SQUAT - PA30 695/UP  
\$795.80 Ea.

**Ignition Switch**

756-115  
All Other PA24  
\$648.50 Ea.  
Alternate \$115.00+  
Call for details  
14314-002  
180-1-2298/2501-2201  
\$525.50 Ea.

**Guard**

17807-000  
Call for Information  
Boot  
10PA1  
\$28.50 Ea.  
Boot Assy 1PA15  
\$50.00  
Bracket/Actuator  
MCD2711H  
\$115.50 Ea. SERV.

**Ground Cable**

17604-029 - 180's  
17604-016  
400/250/260  
Call



All Prices Are Subject to Change Without Notice



01/26/26

## Nacelle Tanks

### FEATURING:

Easy Installation, approximately 35-40 hours.  
Economically priced at \$3500.00 for Complete kit & STC.  
10.2 gallons per side, all useable.  
All enclosed, no external plumbing except vent,  
drain & overflow tubing ends.

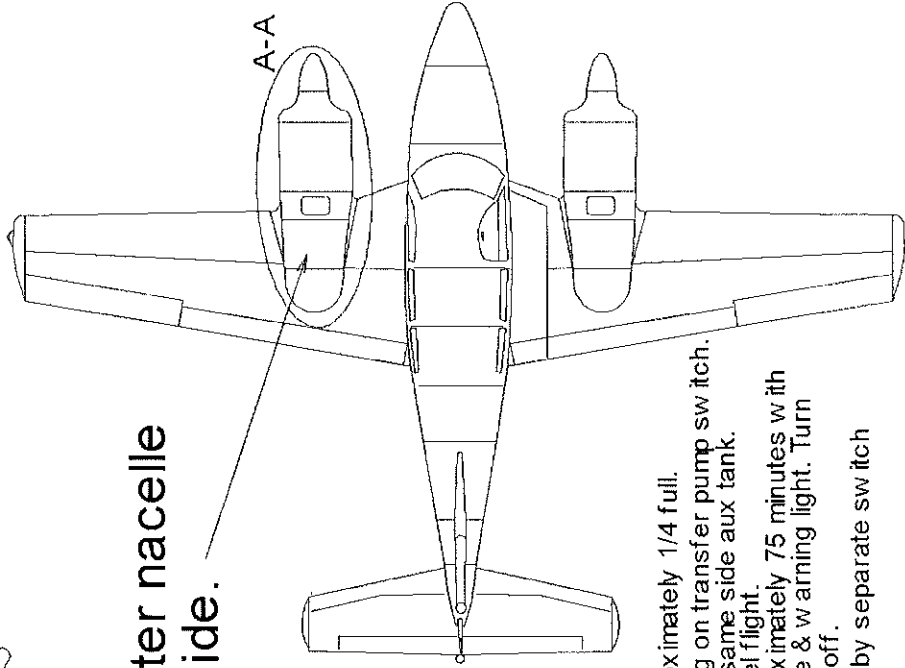
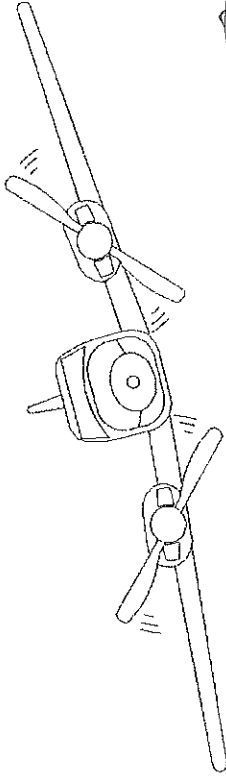

Mounts in center nacelle bay on each side.

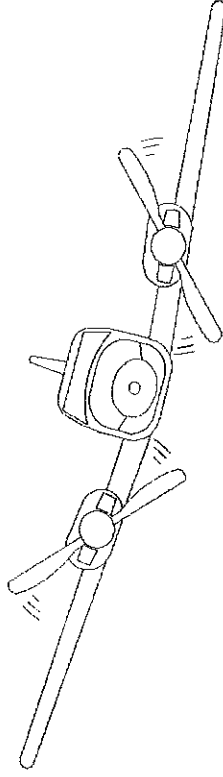

VIEW A-A

LH side shown with center nacelle skin removed.

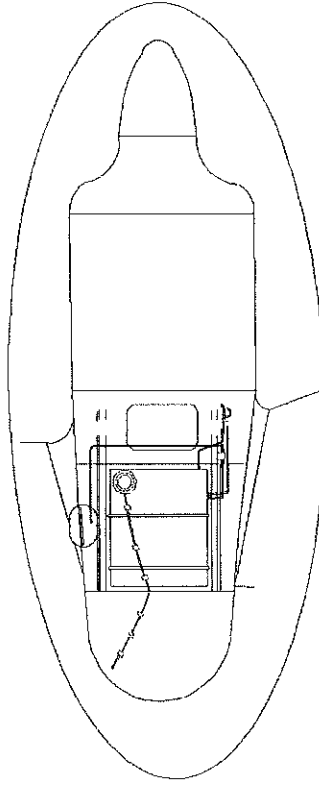

### Operation Procedure:

1. Burn aux tanks to approximately 1/4 full.
2. Begin transfer by turning on transfer pump switch. Fuel is transferred into same side aux tank. Transfer must be in level flight.
3. Transfer will take approximately 75 minutes with completion noted by time & warning light. Turn nacelle transfer switch off.

Note: Each side controlled by separate switch and lights.

FULLY STC'D & PMA'D!  
YOUR MECHANIC CAN INSTALL.

APPLICATION:  
Piper PA30/39, All SN.



**Aircraft**  
Specialists

All Prices Are Subject to Change Without Notice

01/09/25

**PA30 Engine Misc.**

**NON-TURBO**  
460-690 Orig.  
\$Aval?  
PNIA 568.50  
BA105 Assy  
\$45.85 Ea.  
BA10 Element  
\$36.00 Ea.

**TURBO**  
201485 Orig.  
\$198.50 Ea  
BA121 Assy  
\$50.95 Ea  
BA27 Element  
\$25.50 Ea

**Air Filter**

**NOW AVAILABLE**  
**Alternate Air Box**  
23810-000 Assy  
\$850.00 Max. Repair  
(\$75.00 Core Charge)  
**Components**  
23809-010 Door Assy  
Call for Availability  
Hinge/Spring  
Call for Availability  
23809-004 Door Seal  
Call for Availability  
23995-000 Bellcrank/Cam  
Call for Availability  
W25246-000 Bracket  
\$45.00 Ea.

**Oil Cooler Replacement**  
18622-000  
\$564.00 Ea.

**Hanger/Strap**  
W25973-000  
\$43.50 Ea.  
**Attach Clamp**  
80002-076  
Call for Availability

**Baffle Tie Rod**  
10487-006  
Call for Availability

**Breather Tube**  
23845-000  
Call

**Non-Turbo Air Filter Box**  
23883-000  
Call for Information  
**Air Filter Box Lid**  
23886-000  
Call for Information  
**Repairs Offered**

**Tach Reverser**  
451-900  
\$240.00 Ea.  
(C/R Engines only)

**Oil Cooler Hose Set**  
W-OC4  
Call for Pricing

**Pre-Cut Baffle Rubber**  
WBF30NT  
Non Turbo - \$49.50  
WBAF30TB  
Turbo - \$63.25  
*We now carry the metal baffle parts from Airforms*

**Spinner Composite**  
Lifetime Warranty  
23818-000 Comp  
Call  
23818-000 Piper  
Original Aluminum  
\$1900.00/Call  
23819-000 DOME  
\$65.00

**Spinner Bulkhead**  
W23815-000  
\$324.50 Ea.  
W26313-000  
(Heavy Duty & 260C)  
\$378.50 Ea.



**B&C Lightweight Starter**  
10.2 Lbs  
Best Quality Available  
No Bendix Problems  
\$1035.00  
C/R also available

**Exhaust Stack**  
23850-008 RH Front  
23850-010 LH Front  
23850-011 RH Rear  
23850-012 LH Rear  
P.O.R.  
(+ \$100.00 Core Charge on each)

**Waveco Aircraft**  
Comanche Specialists

*All Prices Are Subject to Change Without Notice*

11/21/25  
\*Prices Subject to Change

**PA30 Turbo Misc.**

**Turbo Inlet Scoop  
RJ0617-3  
Call for Info**

**Duct Hose  
RJ9502-20-22-6A  
\$70.40 Ea.**

**Grommet  
RG56W  
\$3.00**

**Duct Hose  
RJ9503-18-19  
\$60.00**

**Duct Hose  
RJ0632  
\$156.85**

**Gasket  
RJ0115  
\$30.80**

**Turbo Air Filter  
201485 Original  
\$198.50 Ea.  
Brackett Brand  
BA121 Assy - \$50.95  
BA27 Element - \$25.50**

**Clamp  
RJ0193  
\$400.00**

**Duct Hose  
RJ9504-28-15  
\$155.00**

**Gasket  
RJ0114  
\$30.80**

11/21/25



All Prices Are Subject to Change Without Notice

## Interior Misc.

PA24 - Later

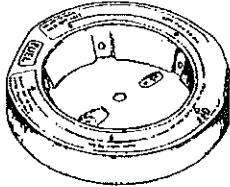

Dish w/o decal - 37.75  
Decal - \$14.50

PA30 - w/o Tips

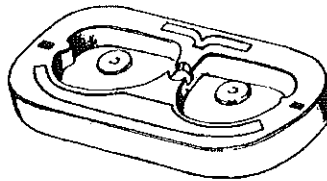

Dish w/o decal - \$35.75  
Decal - \$15.00

PA24 - Early

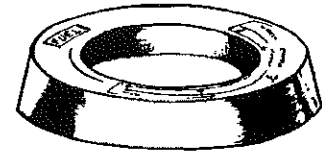

Dish w/o decal - \$35.75  
Decal - \$13.75

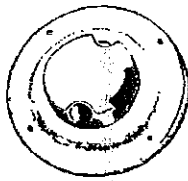

24741 Plate - \$16.50  
21154 Scoop - \$16.50



26441 Plate - \$17.50  
25593 Louver - \$16.50



24741 Plate - \$16.50  
24738 Scoop - \$16.50

## Wing Tip Misc.

Reflector  
20587-002-LH  
20587-002-RH  
Call for Info

Lens  
751-201 RH  
(green)  
\$88.90  
751-202 LH  
(red)  
\$78.80

Bulb  
751-381  
(1512)  
\$28.85

Trim Seal  
19795-000  
(8301)  
\$2.25/ft

Lens  
W20348-00 LH  
W20348-00 RH  
\$43.50  
Made from Lexan

Bulbs  
GE 4509  
\$19.85  
GE Q4509  
\* \$38.50  
Alt \$20.00  
PAR36 LED  
Bulbs  
Start at \$325.00  
Aero Lite  
Alternate \$82.85

Mirror  
(Gear Check)  
WTM1-LH  
WTM1-RH  
\$22.55

Mirror Only  
(PA30 Nacelle)  
\$4.25  
No Cert on parts

### A Good Value

\* The "Q" 4509 bulbs are the best deal. Compare specs:  
4509 - 100 watts, 25 hours, 110,000 Candlepower  
Q4509 - 100 watts, 100 hours, 140,000 Candlepower  
(Brighter, Lasts 3x longer, uses same amount of watts)

11/21/25



All Prices Are Subject to Change Without Notice

## Now Stocking:

### Bogert Battery Boxes, Tow Bars and Bungee Cord Installation Tools

Bogi-Bar Vehicle Tow-Bars  
\$225.00 Ea



STC'd Replacement  
Battery Boxes

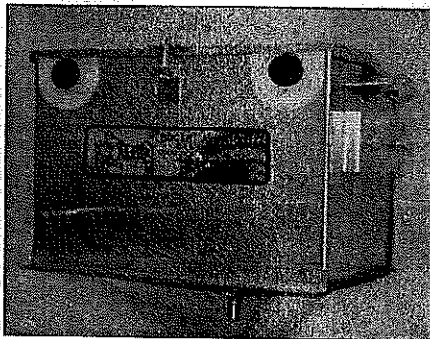

Replaces Both  
Plastic & Metal  
Piper Boxes  
STC'd  
For many Models

Bungee Cord Install Tool  
\$217.00 Ea

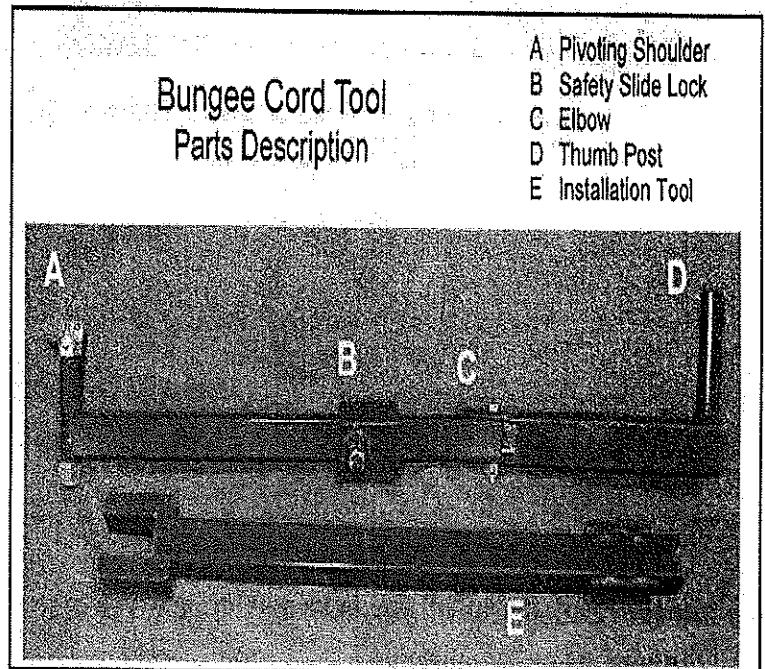

Call for Current  
Pricing &  
Availability

## STC'd Alternator Conversion Kits For Single and Twin Engines

### Single Engine \$1875.00

SKU# SAL12-70

Description: 12/14 volt, 70 amp\*, replaces generators  
On many Piper and Mooney aircraft with Lycoming  
Engines.

Warranty: 2-Year Limited

Alternator Weight: 10 Pounds

Price: \$749.00

\*Aircraft electrical system will be limited by existing wiring and  
Output breaker. The Plane-Power alternator can produce all 70  
amps if proper size wiring and circuit breaker is installed.

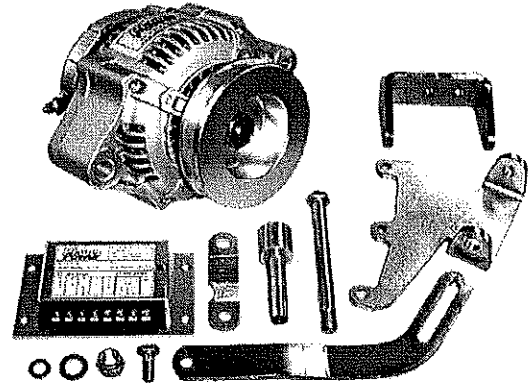

### Twin Engine \$3628.00

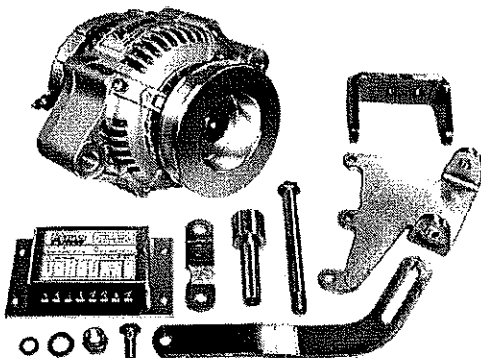

SKU# TAL12-70

Description: 12/14 volt, 70 amp\*  
Alternator kit, replaces generators on  
many twin-engine Piper aircraft with  
Lycoming engines.

Warranty: 2-Year Limited

Alternator Weight: 10 Pounds

Price: \$1499.00

\*Aircraft electrical system will be limited by existing wiring and output  
Breaker. The Plane-Power alternator can produce all 70 amps if proper size  
Wiring and circuit breaker is installed.

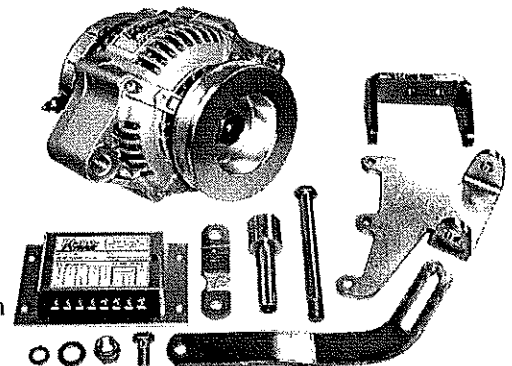



1134 N. Oliver Road, Hgr G \* Newton, Ks 67114 USA

*Check out the Door Steward,  
an STC'd affordable replacement for your door holding woes.*

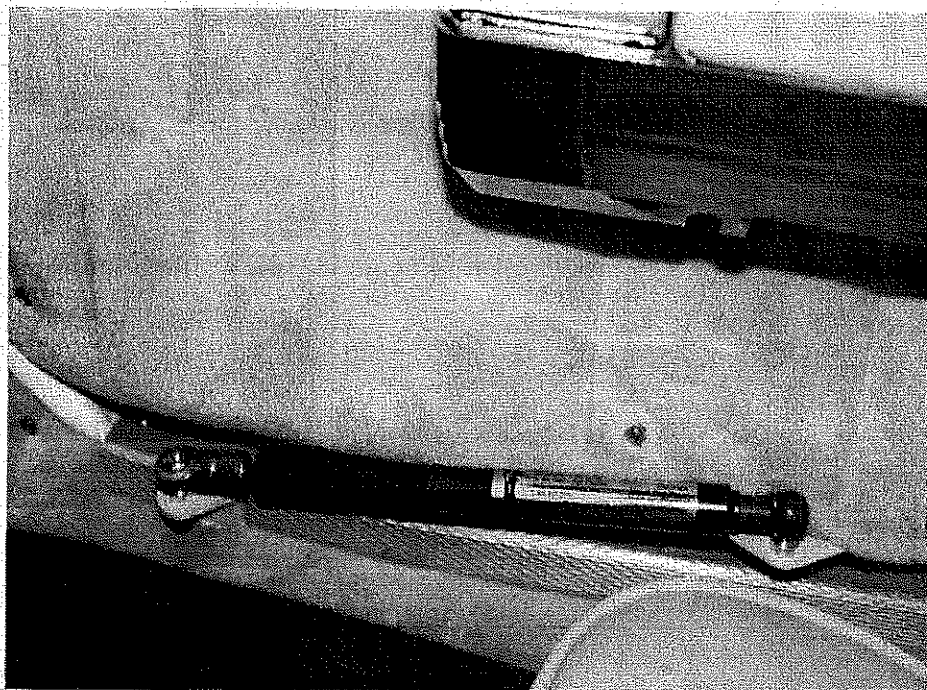
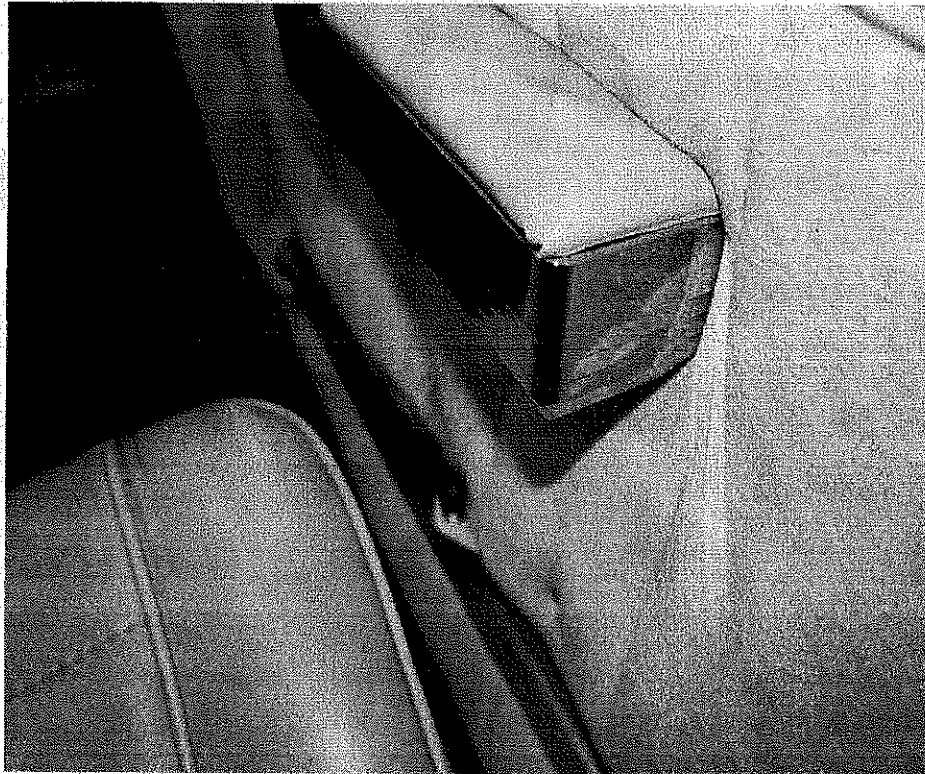

*Only \$276.00 complete.*

*\* All Prices Subject to Change Without Notice.*

**PIPER "GOLD"**  
 FIT ALL PIPER AIRCRAFT MODELS & TYPES  
 GOLD T-NI SPUTTERED OR SATIN BUFFED  
 STAINLESS STEEL ANGLED RINGS & SKID  
 SAFE TO 230+ MPH FRONT OR SIDE GROUND WIND  
**OVER 1000 SETS SOLD!**

Rings and Skid Fit All PIPER Aircraft Types-



GOLD T-NI SPUTTERED ANGLED RINGS \$236/EA



GOLD T-NI SPUTTERED SKID & STRIKE PLATE \$236/EA

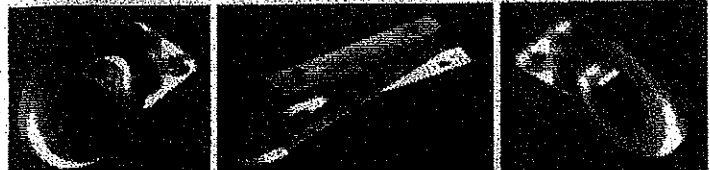

SATIN STAINLESS STEEL RINGS & SKID \$198/EA

Also, NI Plated or White Rings & Skid \$198/EA

FREE SHIPPING & SCREWS (Great Fuel Ground)

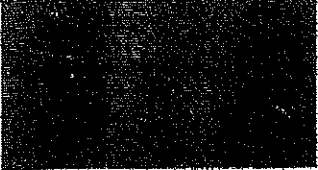
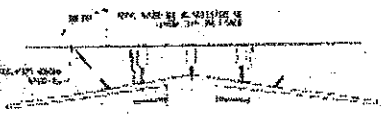

*Now Selling*

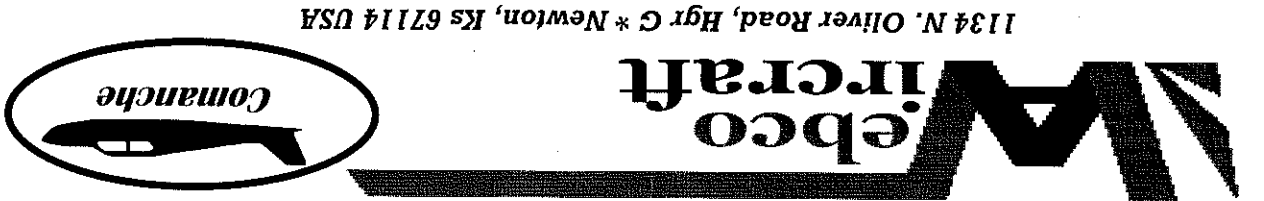

1134 N. Oliver Road, Hgr C \* Newton, KS 67114 USA

NOW AVAILABLE!!!

From Matt Kurke at Comanche Gear two of his publications. Landing Gear Push/Pull Cables Manual and 1000 Hour Gear Inspection Manual.

**Comanche**

Landing Gear  
Push/Pull Cables  
Installation and  
Adjustments Manual

Copyright © 2024  
Webco Aircraft, LLC. All Rights Reserved

Made with pride by:

**Comanche**

Parts and Other Stuff for  
Matt Kurke, A&P, ICS, BSME  
PHONE

**Comanche**

Taking the Mystery out of  
AD 77.13.21, Part A  
for Singles and Twins

Copyright © 2024  
Webco Aircraft, LLC. All Rights Reserved

Made with pride by:

**Comanche**

Parts and Other Stuff for your Comanche

Matt Kurke, A&P, ICS, BSME  
PHONE 316-283-7929  
webcoaircraft.com



Landing Gear Push/Pull Handbook — \$30.00  
1000 Hour Handbook — \$65.00

\* All Prices Subject to Change Without Notice.