

***** Introducing the new ICS *****

**PILOT'S OPERATING HANDBOOK
AND FAA APPROVED
AIRPLANE FLIGHT MANUAL**

"Formerly Published And Produced by the late Douglas L. Killough"

Piper Aircraft ceased production of the Comanche and Twin Comanche in 1972, several years before the General Aviation Manufacturers Association (GAMA) established specifications for the contemporary Pilot's Operating Handbook (POH). As a result, the Owner's Handbook published by Piper is incomplete by modern standards. Now available **EXCLUSIVELY** from the **INTERNATIONAL COMANCHE SOCIETY, INC.**, through it's licensed agents, is the upgraded Pilot's Operating Handbook and FAA approved GAMA format Airplane Flight Manual.

Discounted to current ICS members at \$75.00 each plus shipping (must ask for ICS member discount and provide ICS membership number when placing order) Available **only through Webco Aircraft @ 316-283-7929 www.webcoaircraft.com *Avail Bound or Unbound/Un-punched**

There are **SIXTEEN** different GAMA format manuals available for the Piper Single and Twin Comanche. Please order your manual by "Manual Number 1-16" from the attached chart.

***(Specify "Bound" or "Unbound/Un-punched")**

Order Qty Singles:	Manual	Model	Gross	Year(s)	Flight Manual	SN	SN
	Number		Weight	Mfg	Report Number	Begin	End
_____	01.)	180	2550	1957-64	1047	24-1	3687
_____	02.)	250	2800	1958-60	997	103	2298
_____	03.)	250	2900	1961	1127	2299	2843
_____	04.)	250	2900	1962-64	1179	2844	3687
_____	05.)	250	2900	1962-64	1220 (FI)	2844	3687
_____	06.)	260	2900	1965	1334	4000	4299
_____	07.)	260	2900	1965	1333 (Carb)	4000	4299
_____	08.)	260B	3100	1966-68	1359	4300	4803
Not Avail	09.)	260B	3100	1966-68	1358 (Carb)	4300	4803
_____	10.)	260C	3200	1969-72	1545	4804	6028
_____	11.)	260T	3200	1970-72	1640 (Turbo)	4901	5028
_____	12.)	400	3600	1964-65	1295	26-3	148
Twins:							
	Manual	Model	Gross	Year(s)	Flight Manual	SN	SN
	Number		Weight	Mfg	Report Number	Begin	End
_____	13.)	PA30	3600	1963-68	1269	30-2	1744
				1969	1515	1745	2000
_____	14.)	PA30T	3725	1964-68	1269 (Turbo)	143	1744
				1969	1515 (Turbo)	1745	2000
_____	15.)	PA39	3600	1970-72	1605	39-1	155
_____	16.)	PA39T	3725	1970-72	1605 (Turbo)	1	155

ELECTRICAL:

Light Weight Starter (8 lbs. lighter, cranks faster, no bendix to stick, STC'D)
No more Hot Starts, 10.2 lbs total weight\$ 775.00
Battery Cable Kits Using M22759/16-2-9 Per MSB836A 180 & 250 (starter solenoid located top pilot side) \$210.00
180 / 250 / 260 (starter solenoid on bottom co-pilot side) \$195.00
260B - \$130.00 / 260C - \$192.50 / PA30 - \$245.00 / 400 - \$210.00
Starter Solenoid 487-149 (602-850)..... \$115.00

REPLACEMENT GASKETS:

Fuel cell gasket set PA24 (includes all 5 gaskets needed) \$55.00/Tank
Fuel cell gasket set PA30 (includes all 6 gaskets needed) \$66.00/Tank
Fuel door gasket W20327-003 \$6.35 PA30 Aux W19051-000 \$6.35
462-021 Fuel sender gasket . Call 751-871 Fuel Screen Gasket Call
462-014 Large oval cork Call 22846-000 Fuel filler PA30 Aux
20366-000 Blk oval (upper thin) 20366-002 Blk oval (lower)

FUEL SYSTEM:

Fuel Bowl - W22034-00 (180/250/260) \$145.00 Drain valve 22179-00 Call
Fuel screen combo W22458-000 (PA24 fuel bowl gasket w/screen) . . \$48.50
Fuel screen strainer PA30 fuel valve P.O.R.
Fuel sender (transmitter) 20966-000 Main / 20966-002 Aux P.O.R.
Fuel caps (WEBCO PMA'd) 180/250/260/ PA30 Main or PA30 Aux \$60.00
Rubber replacements (fuel caps) (Main / Aux / Tip tank) \$19.25
12 volt Electric Fuel Boost Pump (Bendix/Facet style Carb. engines) \$678.00
Fuel Selector wafer switch PA24 (W22843-000) \$195.50
PA30 Fuel selector decal set \$15.00 PA24 Fuel selector decal set \$13.75
PA24 or PA30 fuel selector dish (without decal) \$35.75
Brand New Multi-Ply fuel cells Main & Aux. Call for \$\$\$

GEAR & BRAKE MISC.

Strut seal kits (PA24 or PA24-400/PA30) (one per gear) . . . \$15.50
Master Cylinder oring sets \$1.95 to \$7.25
Bungee Arms W20846-006 Left & W20846-007 Right (Heavy wall) \$325.00
Bungee Cords (31322-007 or 8097) \$31.00
Main Gear door hinge W21065-012 \$34.50
Hub Cap / Wheel cover (round) . . . \$10.20 (raised) . . . \$32.25/\$26.80
* COMANCHE Bushings and Bolts - Give us a Call... We stock 'em ALL! *

ENGINE & EXHAUST MISC.

*260 Heated Alternate air induction kit (STC'D) (AD 91-02-06) . . . \$950.00
* Turbo Rotary fuel pump metered fuel fitting (AD 91-08-07) . . . \$45.00
W16559-000 Carb to airbox coupling boot (accordion style) . . . \$325.50
Carb airbox- PA24 Repair Available.....Max \$750.00
Airbox Repair Parts/Kits Available.....Call for Information
Tach Cables (inner core only) PA24 PA30 . . . Call for Information
Tailpipes 180/Call 250 PMA \$245.00 260 LH or RH Call Tailpipe clamp Call
Oil Cooler Hose Kit 180/250/260 .. \$350-\$495 / PA30 (1 Kit / Eng) \$190.00
Or send your hoses in for repair.
Muffler shroud (PA24) W23489-000 \$489.50
Carb Heat Shroud -Lower 180 PMA'....\$104.50 Others avail upon request
Baffle rubber kit - 180/250/260/PA30 \$49.50
Felt for baffles \$49.50 Rubber AND felt kit \$94.50
Vernier Throttle Kit (Black) w/switch.....Call for other engine cable options
Prop Governor Cable.....Call for other engine cable options
Mixture Control Cable.....Call for engine other cable options
(* All 3 above cables require 337 field approval)
Vernier Control Cable-112"-FAA-PMA'D.....\$245.00
All Control Cables for PA30 (Push/Pull) . . . Call for Price & Availability
Don't forget to ask about our nacelle auxiliary tanks for PA30/PA39

DOOR:

Upper Door latch kit (STC'd - Cherokee style) \$785.00
Lower hinge area repair kit (brace/reinforcement) Call for info
Holder (catch) repair kit (spring & rollers for door holder) \$18.00
Cabin Door Seal - Regular/(PA24 co-pilot side baggage doors) \$5.95/Ft
Baggage Dr Seal PA24 Pilot side & all PA30 (23183-000) 10' len \$73.10/44.85
Plus Inner Cord (for the 23183-000).....187-652 (8' len) \$3.00/Ft
Door Lock mechanism (Reg) \$16.50 or (Tubular Cam). \$26.85
Interior handle Piper \$90.00 or *** Call for options

WINDOWS:

<Clear> <Tint>
1/4" STC'd Complete Set - 4 place (less windshield) Call.....Call
1/4" STC'd Complete Set - 6 place (less windshield) Call.....Call
Windshield 1/4" 1 PC (FOB factory) Call.....Call
Windshield 1/4" 2 PC (FOB factory) (each) Call.....Call
Caulking/Sealant for windows/windshield (per tube) \$5.00

MISC:

Make all your orders easy. Complete PARTS or SERVICE manuals
Parts/Service PA24 Parts/PA30 Parts....\$58.50 PA30/39 Service \$70.00
Aileron Bulkhead Kit (763-893) \$1923.40
Hinge Bracket kit (760-914) Call
PA30 Rudder Tip \$238.90 PA30 Beacon Fairing \$?
Stabilator tip PA24 or PA30 - Plastic Call Fiberglass \$187.50 / \$160.00
Tail Cone Fairing (Fiberglass) \$132.00
Wing root seal Upper set (2 wings) \$92.70 Lower set (2 wings) \$44.50
Wing tip mirrors (visually check gear down) Call for info
Nav Light reflectors (visually check your nav lites) RH or LH Call for Info
Landing Light Lenses W20348-000 LH & W20348-001 RH (LEXANI) \$43.50
Trim Seal (J Channel) \$2.25 per foot
Cowl Chafe Cotton seal strip ...Starting at \$1.00/FT various widths
Canvas Nose wheel cover PA30 23956-000 Call for Info
Wheel well liner/cover PA30 or PA24 (LH or RH) Call
PA30 Nose bowl hinges - Hinge pin upper or lower Call-Repair Parts Available
Cowl support rod (PA24) Call for Info
Heated Pitot Tube Call for Info Pitot tube mounting mast Call for Info
Rubber steering rod boot 21378-000 \$50.00
NEW SKIN STOCK AND BULKHEAD BLANKS
Flap, Aileron, Rudder, Stabilator, Fuselage and Wings. Most Available.
CALL.

ACCESSORY REPAIR/EXCHANGE

Gear Transmission / Flap Transmission
Call for Current Options
Fuel Selector Valves
PA30 - (Airborne 1H7 Series) repair base price \$450.00
(New Strainer screen Market Price)
New brass valve for Experimental
Hoof valve repair available -Starting at \$300
PA30 Heater regulator valve (exchange) \$CALL\$
Weldon Boost Pumps (injected, PA30 ONLY) \$CALL\$
Generator Exchange 50Amp Delco-Call for availability
70 AMP Stc'd Alternator Kit
Single.....SAL12-70.....\$1885.00
Twin.....TAL12-70.....\$3628.00

New

Now Stocking PMA'D PA24-180/250/260
Lower Cowl Scoops

Main Gear Misc.

Link Rod
20768-000 LH 180/250
20768-001 RH 180/250
24911-000 (260 & 260B)
22577-000 (400/30 sn 2-694)
25046-000 (260C/PA30 695/UP)
P.O.R.

Rod End Bearing
W23412-000
180/250/260A&B
Call
W22943-000
(260C/400/PA30)
Call

Bolt
400-313
(180/250/260A&B)
\$9.65 Ea.
400-368
(260C/400/PA30)
\$9.90 Ea.

Spherical Bearing
452-367
Generic \$56.72 Ea.
(180/250/260A&B)
751-454
(260C/400/PA30)
\$166.12 Ea.

Bolt 400-016
\$1.50 Ea.
Bushings
14843-069 (Long)
\$58.00 Ea.
14843-079
(Short)
\$23.95 Ea.

Bungee Cord
31322-007
(8097)
(All Models)
\$31.00 Ea.

Spring
83302-040
\$48.50 Ea.

Bushing
20737-008
\$123.00 Ea.
per link assy
4 per A/C

Bolt
400-761
\$11.75 Ea.

Bushing
W20737-006
(180/250)
W20737-014
(260/400/PA30)
\$40.00 Ea.

Shims
14843-020
(.125" thick)
14843-093
(.062" thick)
19513-010
(.035" thick)
Call for Info

Bolt
401-346
(5 & 1/16")
\$14.50 Ea.
401-347
(5 & 3/16")
\$12.50 Ea.

Bungee Arm
Thick Wall
W20846-006 LH
W20846-007 RH
\$325.00 Ea.

Bushing
14843-060
\$95.50 Ea.
Bolt
400-757
\$11.50 Ea.

Bushing
W14843-030
\$26.75 Ea.

Bushing
W20737-005
(180/250)
W20737-013
(260/400/
PA30)
\$40.00 Ea.

Bushing
14843-016
\$14.75 Ea.
(4 per link assy)
(8 per A/C)

Stud
W20829-000 (180/250)
\$185.00 Ea. Piper \$263.00
W22512-000 260/400/30)
\$185.00 Ea. Piper \$308.50

PA24 Owners:
Be aware that crack-
ing is common on the
thin wall bungee arms.

Bushing
W14175-050
\$26.50

Gear Door Misc.

Bracket
21320-006
Fore/Front
21322-006
Fore/Rear
Call for Info

Clevis
454-901
\$26.95 Ea.

Eye-Bolt
402-032
\$12.10 Ea.

Bracket
21320-007
Aft/Rear
21322-007
Aft/Front
Call for Info

Hinge
W21065-012
\$34.50 Ea.

Bracket
21068-00 LH/001 RH (180/250)
24842-00 LH/001 RH 260A/B)
24819-000 LH/001 RH
(260C/400/PA30 695 & UP)
22825-000 LH/001 RH (30 1-694)
Call for Info

Bushing
W80012-097
\$10.00 Ea. or
80012-006
\$25.00 Ea

Hinge
W21318-000
\$45.00 Ea.

Rod End
W452-383 \$18.50V
CA452860A \$57.50
Call for Info

Rod Assy
Complete
W21067-003
\$89.50 Ea.

Bushing
14976-009
\$28.00 Ea.

Rod Assy
Complete
21118-003
Call for Info

Horn
21317-000
Call for Info

Spring Washer
408-833
\$10.60 Ea.

Horn
21066-000
Call for Info

260C & PA30
Nose Gear
Doors
Repair Parts
Available
Call for Info

Bumper
Gear Door
453-887 Thin
\$7.25 Ea
453-646 Thick
\$2.90 Ea

Gear Door
LH 22984-000
RH 22984-001
Call for Info

Weberco
ircraft



All Prices Are Subject to Change Without Notice

5/29/26

Nose Gear Misc.

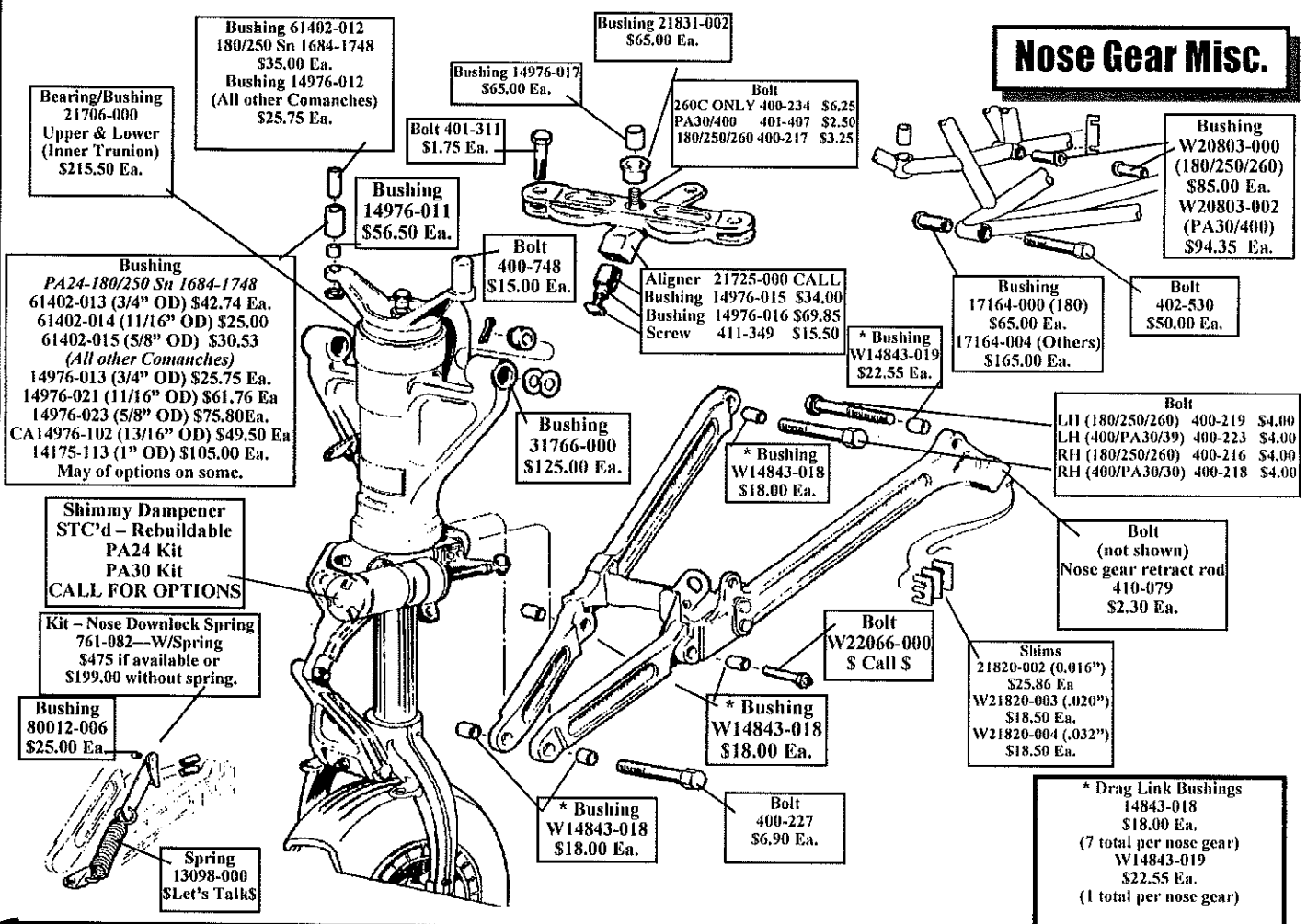

Strut Misc.

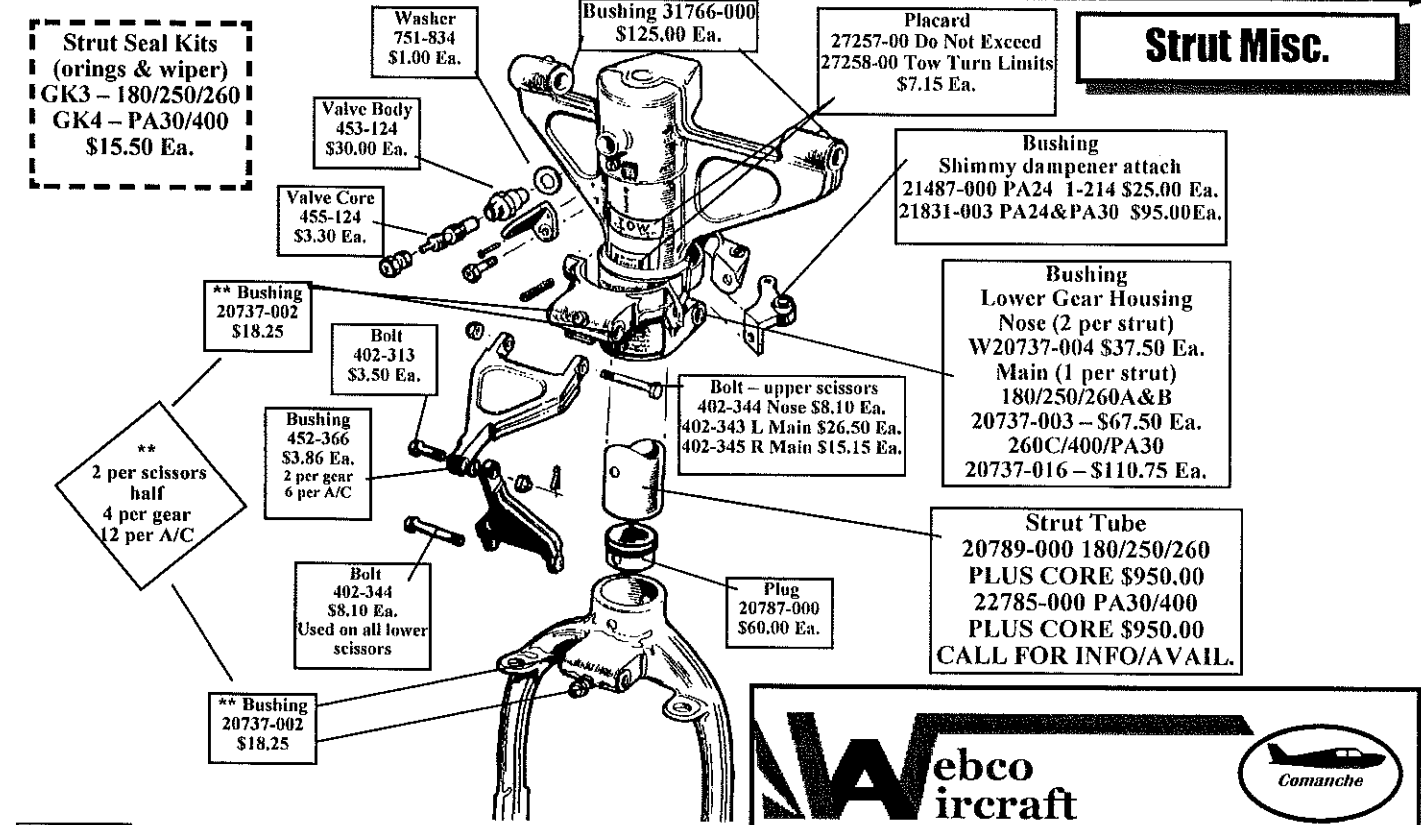

5/29/26

All Prices Are Subject to Change Without Notice

AVAILABLE SOON !! *
ALL NEW - FAA-PMA'd**

**Comanche Gear Push-Pull Conduits
P/N W455-180**

**Featuring:
All New Design
Stainless Steel Construction
Closed Seal System
Teflon Inner-Lined
No Lubrication Needed
Less Load on Transmission Assy
S TBA ***
Piper's \$1390.08 Ea.**

Gear System Misc.

Spring
Gear Trans. Emergency Release
83302-039
(PA24 SN 1-3557)
Call for information
83302-031
(All Other Comanches)
Call for information

Clevis Stud
Nose Gear Drag Link
20859-003
(PA24-180/250)
Call for availability
23103-000
(All Other Comanches)
Call for availability

Nut
Gear Conduit
21063-000
Only used available

Camloc Stud
Gear Access Door
(Folding)
487-668
Call for Availability

**DRESS UP YOUR
INTERIOR!
PLATE**
Gear Lever
Boot Attach
W21207-000
\$ 38.50

Gear Lever Boot
Replacement
21280-000
Call for options

Tube - Inner
Nose Gear Trunion
21707-000
Call for Repair Options

Rod End Bearing
Gear Conduit
452-377
\$382.00 Ea.

Drag Links
Nose Gear
20814-000 LH Front
20815-000 RH Front
20819-000 RH Rear
20817-000 LH Rear
(180/250 SN 1-3225)
23109-000 LH REAR
(all other Comanches)
Used/As Removed
Call for Price &
Availability

Rod End Bearing
Nose Gear Rod
452-356
(PA24 180/250 SN 1-
3530)
\$68.50 Ea. (NLA)
Can use
CA452-412
(All Other Comanches)
\$60.00 Ea.

KEEP YOUR GEAR UP TO SPEED
We stock all Comanche Gear Parts Including:
**BUSHINGS / BOLTS
LINKS / ROD ENDS
CIRCUIT BREAKERS / SWITCHES
WIRING HARNESES
SOLENOIDS / SPRINGS
GIVE US A CALL!**

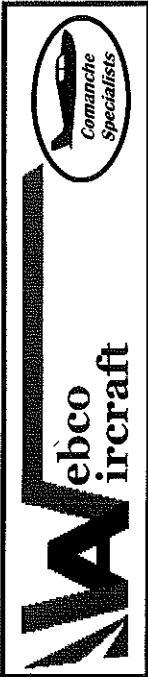

Webco Aircraft
All Prices Are Subject to Change Without Notice

11/21/25 *Prices subject to change



1134 N. Oliver Road, Hgr G * Newton, Ks 67114 USA
Ph. 316-283-7929 Fax 316-283-4702 Email: Sales@webcoaircraft.com

SOON AVAILABLE!! ***
ALL NEW - FAA-PMA'd
Comanche Gear Push-Pull Conduits
W455-180

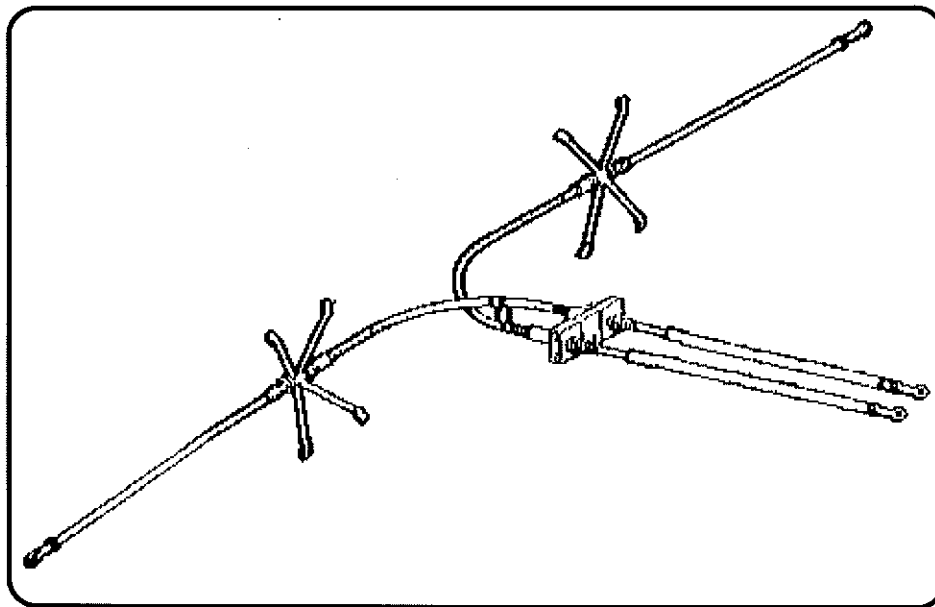

Featuring:
All New Design
Stainless Steel Construction
Closed Seal System
Teflon Inner-Lined
No Lubrication Needed
Less Load on Transmission Assy
TBA ***
Piper's \$1390.08 Ea

Tail Section Misc.

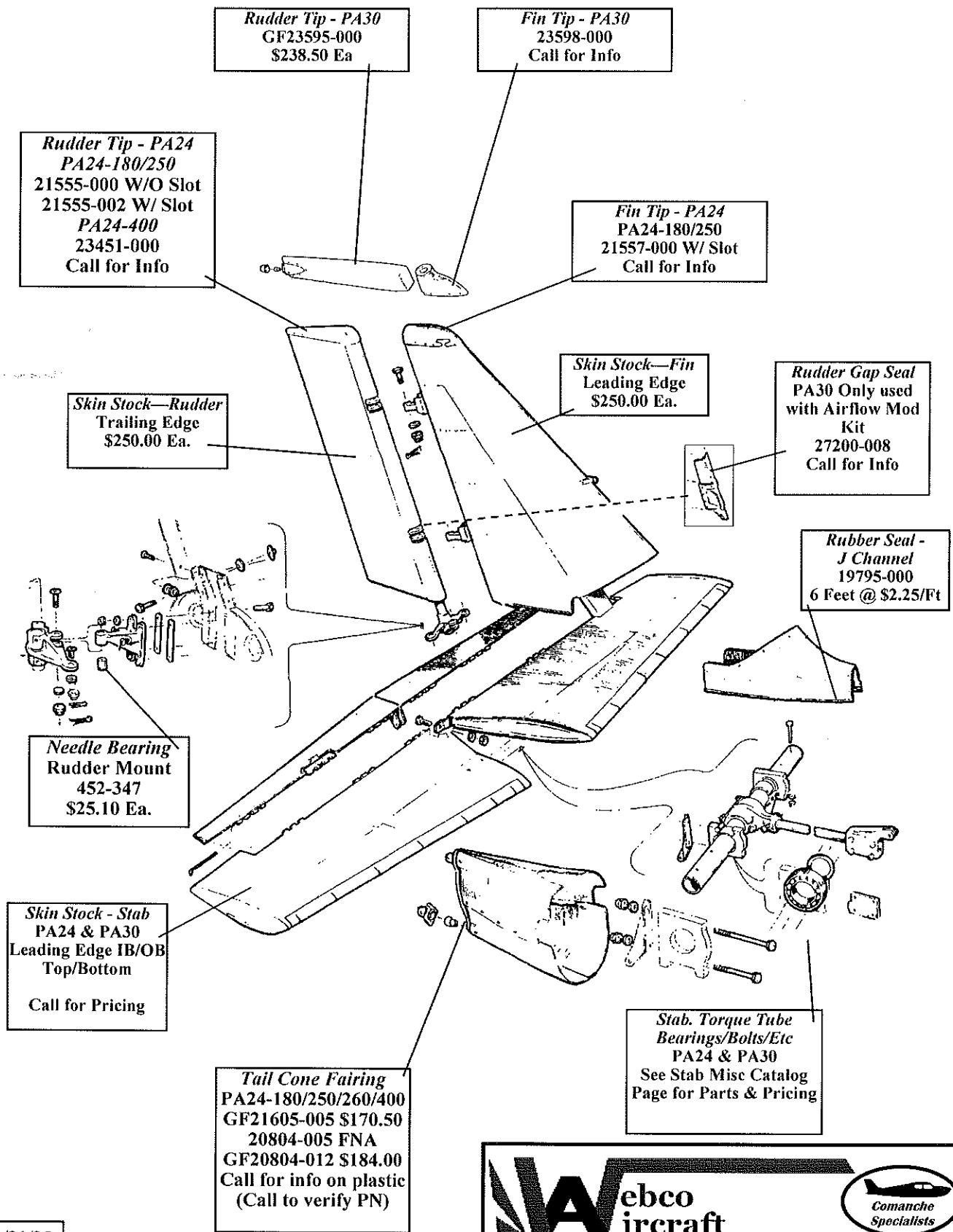

Rudder Tip - PA30
GF23595-000
\$238.50 Ea

Fin Tip - PA30
23598-000
Call for Info

Rudder Tip - PA24
PA24-180/250
21555-000 W/O Slot
21555-002 W/ Slot
PA24-400
23451-000
Call for Info

Fin Tip - PA24
PA24-180/250
21557-000 W/ Slot
Call for Info

Skin Stock—Rudder
Trailing Edge
\$250.00 Ea.

Skin Stock—Fin
Leading Edge
\$250.00 Ea.

Rudder Gap Seal
PA30 Only used
with Airflow Mod
Kit
27200-008
Call for Info

**Rubber Seal -
J Channel**
19795-000
6 Feet @ \$2.25/Ft

**Needle Bearing
Rudder Mount**
452-347
\$25.10 Ea.

Skin Stock - Stab
PA24 & PA30
Leading Edge IB/OB
Top/Bottom
Call for Pricing

Tail Cone Fairing
PA24-180/250/260/400
GF21605-005 \$170.50
20804-005 FNA
GF20804-012 \$184.00
Call for info on plastic
(Call to verify PN)

**Stab. Torque Tube
Bearings/Bolts/Etc**
PA24 & PA30
See Stab Misc Catalog
Page for Parts & Pricing

11/21/25



All Prices Are Subject to Change Without Notice

Stabilator Misc.

Bolt
 502-329 AN174C32A \$34.50 Ea. 180/250/260
 502-342 AN175C32A \$32.50 Ea. PA30/400
 (4 per A/C)

Bolt
 400-932 (AN24-46A) \$18.75 Ea. All Models
 (2 per A/C)

Bolt
 691-352 * (NAS6604-29) \$4.50 Ea. All Models
 (1 per A/C)
 * Replaces 402-321

Bolt
 502-343 (AN175C33A) \$32.50 Ea. All Models
 (2 per A/C)

Bearing
 W452-363 \$285.00 Ea.* All Models
 (2 per A/C)

Bolt - Lower
 401-380 AN5-54A \$19.85 Ea. 180/250/260
 401-382 AN5-56A \$18.85 Ea. PA30/400
 (2 per A/C)

Bolt - Upper
 401-383 AN5-62A \$ CALL \$ 180/250/260
 401-384 AN5-63A \$25.00 Ea. PA30/400
 (2 per A/C)

Hinge Half (Tab side)
 20194-018 16914-000 (180/250/260)
 (PA30/400)
 Call for Info

Hinge Half (Stab side)
 20193-028 (180/250/260/30)
 Call for Info
 16194-000 (400)
 Call for Info

Hinge Pin
 21510-000
 21510-002
 Call for Info
 (6 per A/C)

Stab Tip Block *
 20257-002 (Front, all but 400)
 20257-003 (Rear, all but 400)

Stab Screw *
 415-289 Rear
 415-292 Front
 \$2.75 Ea.

Stab Tip
 180/250/260 Early PA30
 21556-000 Plastic Call
 21556-000F Fiberglass \$198.00
 Late PA30 / 39
 25066-000 Plastic Call
 25066-000F Fiberglass \$185.00

* Parts are different for PA24's with Stab Weight Mod kit installed.

11/21/25



All Prices Are Subject to Change Without Notice

Stab Trim Misc.

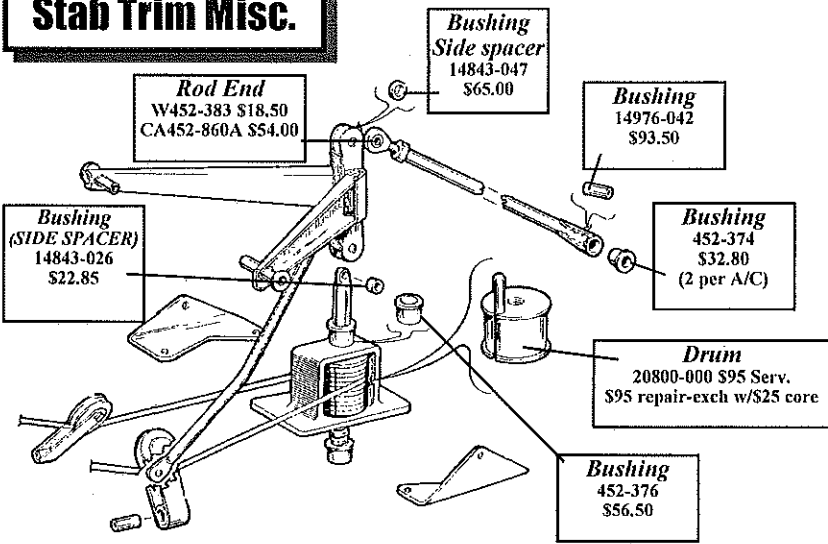

Rudder Pedal Misc.

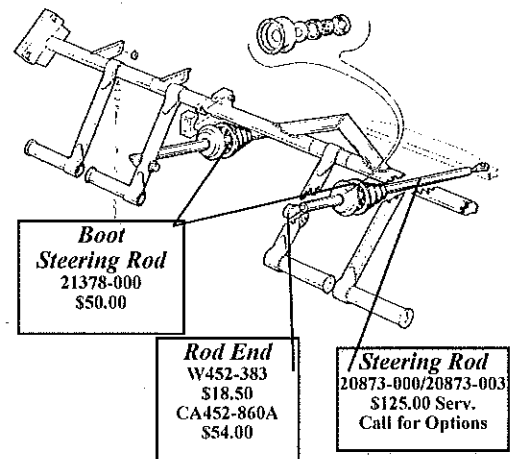

Elec. Flap Misc.

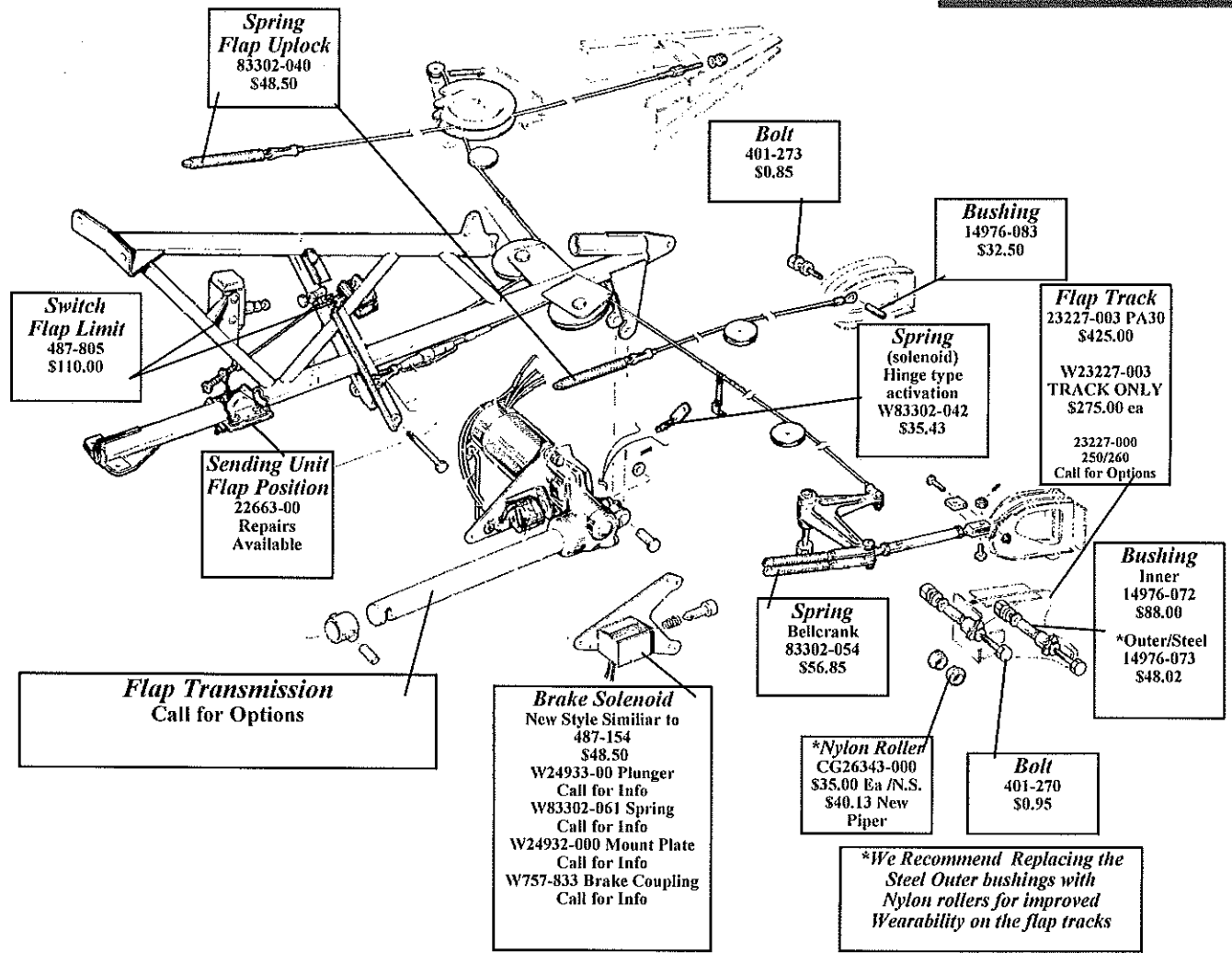

Fuel System Misc.

CamLoc Stud
 487-590 W/SS (2600-5SW) \$12.75
 487-692 W/SS (2600-8SW) \$12.50
 Stainless, Wing Head
 487-590 S/SS (2600-5S)
 Stainless, Slot Head
 \$11.85 Ea.
 494-060 Star Lock Washer
 \$0.68 Ea.

Fuel Door Gasket
 Call for Info
 20327-003
 PA24 Main/Aux / PA30 Main
 19051-000
 PA30 Aux / PA24-400 Aux
 Call for Info

Fuel Transmitters
 20966-000 All Main Tanks
 20966-002 All Aux Tanks
 Repairs Available
 751-884 Tip Tanks
 P.O.R.
 494-063 Sender Washer
 \$0.78 Ea.
 751-767 Sender Float
 \$14.00 Ea.
 462-021 Sender Gasket
 Call for Info

Webco PMA'd Fuel Caps
 \$60.00 Ea.
 (keep water out and fuel in)
 WFC1 - PA24 Main & Aux, PA30 Main
 PA30 Aux, PA24-400 Aux
 Piper Style (Flip handle) \$139.50

Fuel Door Lock
 DL5
 \$16.50 Ea.
 (similar to Cabin/Baggage door locks)
 Tubular style
 DL5T
 \$27.50 Ea.

Fuel Cell Gaskets
 20366-000 Upper, Thin
 20366-002 Lower, Thick
 462-014 Oval, Cork
 22846-000 PA30 Aux
 Call for Info
Gasket Set
 PA24 Main/Aux, PA30 Main
 (includes 5 gaskets)
 \$55.00 Per Tank

PA30 Aux
 (includes 6 gaskets)
 \$66.00 Per Tank
PA24-400 Aux
 (includes 12 gaskets)
 \$137.50 Per Tank

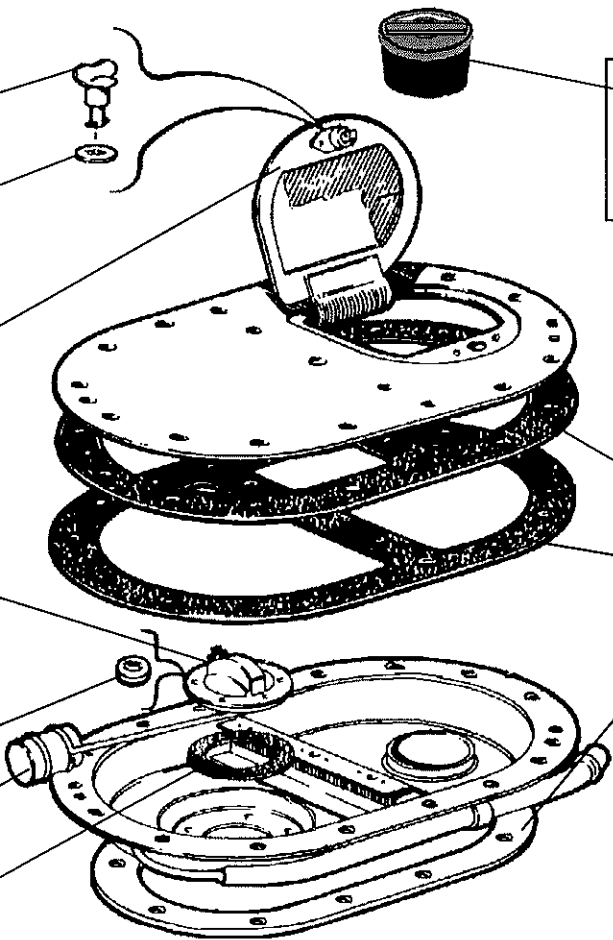

Fuel Strainer Assy
 PA24 SN 24-2299 & Up

Clamp Assy
 22306-000
 P.O.R.
 Snap Ring
 484-728
 \$8.00 Ea.
 Fuel Strainer Screen
 W22458-000
 \$48.50
 Fuel Sump Bowl
 W22034-000
 \$145.00
 Drain Valve Assy
 22179-000 Type
 \$26.80

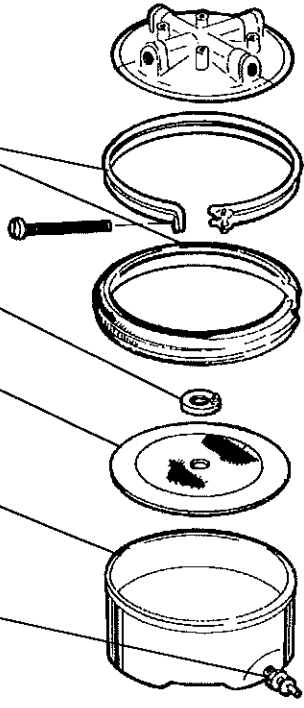

Fuel Strainer Assy
 PA24 SN 24-1 To 2298

Cover Assy
 14428-000
 \$130.00 Ea.
 WHEN AVAILABLE
 Fuel Strainer Screen
 750-272
 \$4.95 Ea.
 Fuel Strainer Gasket
 85012-032
 \$4.95 Ea.
 Drain Valve Assy
 CCA1550/492-022
 \$22.50 Ea.
 SEAL ONLY \$8.85
 Wire Assy (Bail)
 494-644
 Call for Info



11/21/25

All Prices Are Subject to Change Without Notice

Cabin Door Misc.

WDL1
Upper Door Latch Kit - \$765.00
(8-12 Hours, Avg. Installation)

DS3
Cabin Door Seal
Regular or Hollow
\$6.50 per foot
11 FT REQUIRED
MITRE LOWER CORNERS

1/4" Side Window Sets

	Clear	Bronze/Gray
4 Place	\$1000.00	\$950.00*
6 Place	\$1260.00	\$1200.00*

(14-18 Hours Avg. installation time-Clean up Prep takes the longest)

*Green Tint available at extra charge
Set includes frameless vent in Pilots window.
(frameless vent in Co-Pilot window available at extra cost)

464-022
Door Handle
\$90.00 / Piper
Call for options

DK2
Reinforcement Brace
(Lower door hinge area)
\$82.50
Repair Part
(2-4 hours avg. install time)

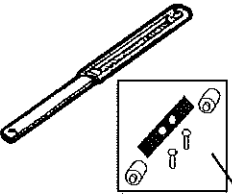

WDK1 - Holder Repair Kit
(spring, rivets, rollers / repair your existing holder)
\$18.00

Webco Now Stocks the Door Steward
Pneumatic Door Holder STC'd Kit at \$290.00

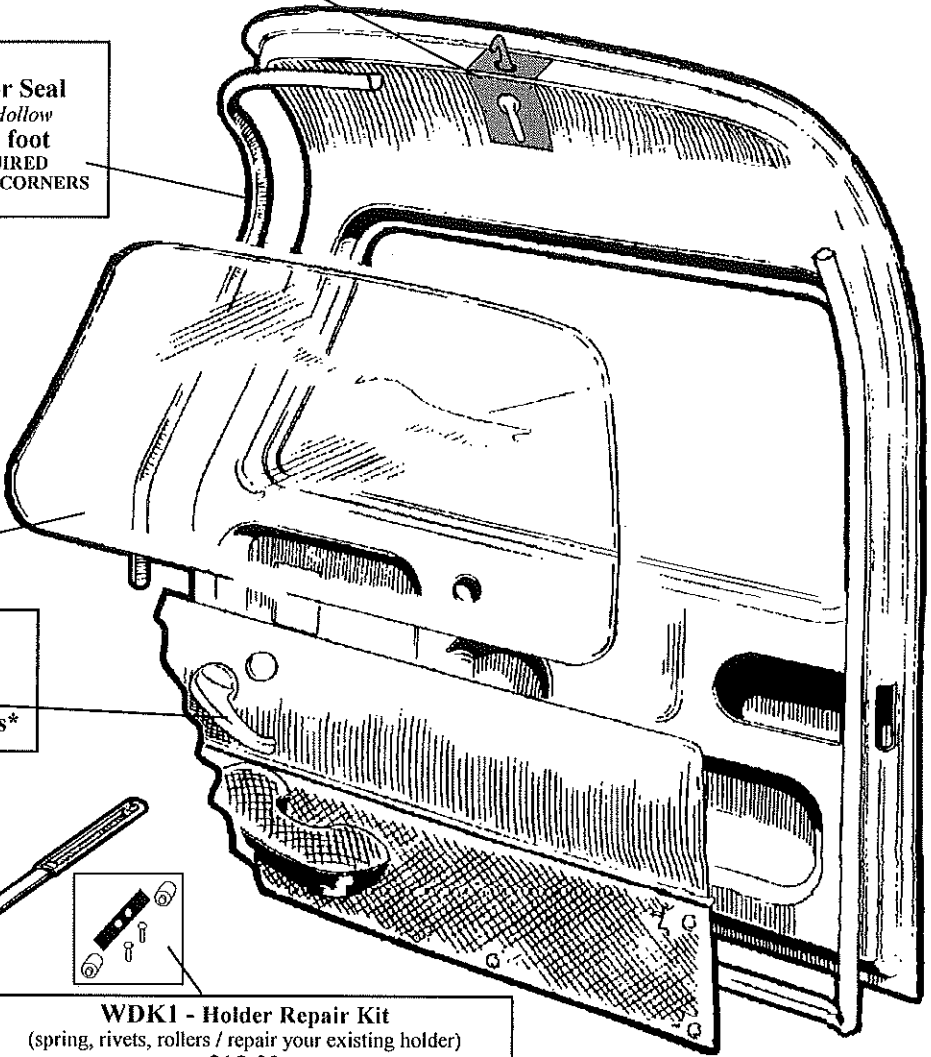

Baggage Door Misc.

Baggage Door Seal
(PA24 w/Door on Co-Pilot Side)
(same as cabin door seal)
\$6.50 per Foot
(7 feet required)

(PA24 Pilot Side Door)
(PA30 All baggage Doors)
\$73.10 or \$46.50
per 10' Len
(PN 23183-000)
Inner cord (8ft) \$24.00

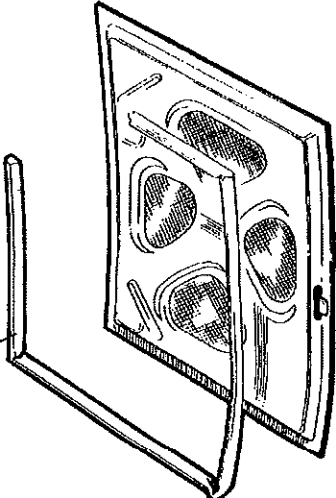

DL4 / DL5 Door Lock
\$16.50

DLST
Tubular Door Lock
\$27.50
(May be ordered keyed alike for use on both doors)



11/21/25

All Prices Are Subject to Change Without Notice

Intake & Exhaust Misc.

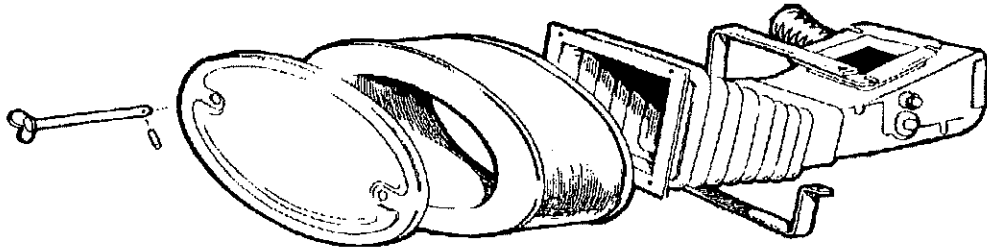

Stud 487-616 Call for Info	Pin 480-650 \$1.50	Air Filter Cover 16553-002 \$150.00	Air Filter Assy BA104 \$44.95 BA3 \$24.98	Coupling Boot W16559-000 \$325.00	Airbox Assy 21943-003 Call for Info
---	---------------------------------	--	---	--	--

Bushing & Shaft Repair Kit for ABOVE airbox – WAB3
 Butterfly flapper valve replacement for ABOVE airbox – WAB4
 (Bracket air filters and elements available for all other Comanches except 400)
 Bushing & Shaft repair kit for EARLY 250 airbox – WAB5
 Butterfly flapper valve replacement for EARLY 250 airbox – WAB6
 Bushing & Shaft repair kit for EARLY 180 airbox – WAB1
 Butterfly flapper valve replacement for EARLY 180 airbox – WAB2
 * Call for Information

**Muffler Shroud
(without plenum)**
 180 – SN 1 to 102
 W23503-000
 Call for Repair Options

180/250 SN 103-2298
 W23504-000
 Call for Repair Options

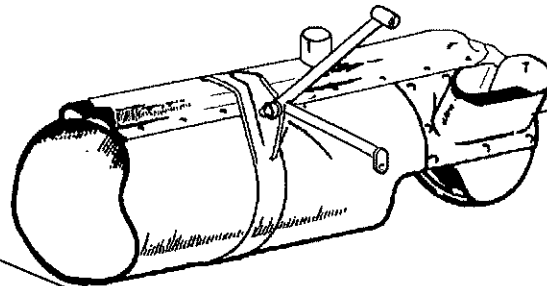

**Muffler Shroud
(with plenum)**
 SN's 2299 & Up
 180 – W23507-000
 Call for Repair Options
 250 – W23489-000
 \$489.50

Muffler Clamp
 180/250 (2 9/16")
 W14235-008
 (some 180's use 2 1/16")
 W14235-000
 Call for Info

Shroud Clip
 W21247-000
 \$45.00

Tailpipe Clamp
 W21167-000
 Call for Info

Tailpipe
 180 – W21580-002
 Call for Info
 250 – W21580-000
 \$245.00

We also offer
 Exhaust gaskets.

Use measurement to identify
 Correct 250 carb shroud

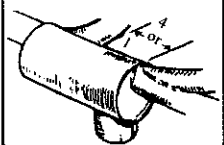

Carb Heat Shroud
 180 Lower – W21165-003
 \$265.00
 250 Lower – W24473-000
 Call for Options

180 Upper – W21165-002
 (SN 1-2298 w/90 deg takeoff)
 180 Upper – W22093-000
 (SN 2299/Up w/45 deg takeoff)
 *Call for options
 250 Upper – W24472-002
 (with 1 7/8" measurement)
 250 Upper – W24542-000
 (with 4 1/4" measurement)
 *Call for Options

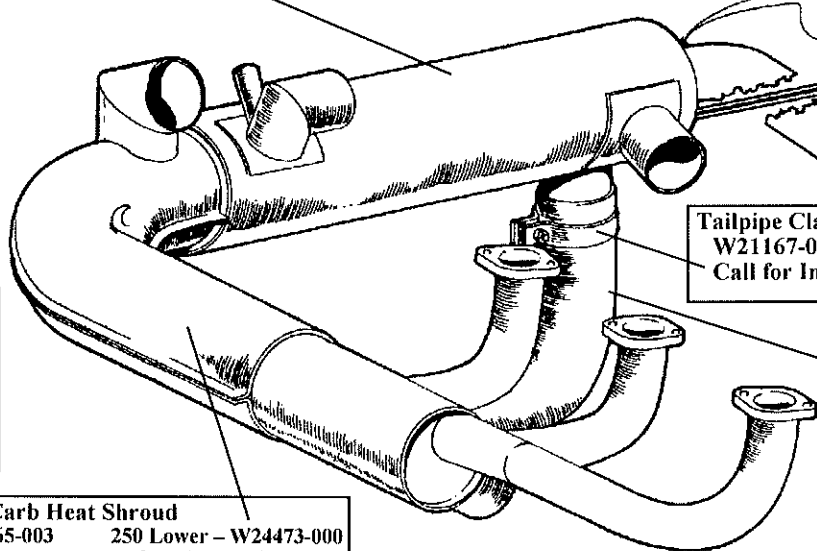

09/11/25

All Prices Are Subject to Change Without Notice



1134 N. Oliver Road, Hgr G * Newton, Ks 67114 USA
Ph. 316-283-7929 Fax 316-283-4702 Email: sales@webcoaircraft.com

Distributors of
Brand New
Comanche Fuel Cells

FAA-PMA Approved
Tested MULTI-PLY Construction

We have both Main & Aux
180/250 Early Main \$1295.00
250/260 Later 400 / PA30 Main \$1325.00
250/260 Aux \$1260.00
PA30 Aux \$1275.00
Call for options on 400 Aux

Fuel cell gasket set PA24 (includes all 5 gaskets needed)....\$55.00/Tank

***DISCOUNTED WITH FUEL CELL PURCHASE**

Fuel cell gasket set PA30 (includes all 6 gaskets needed)....\$66.00/Tank

***DISCOUNTED WITH FUEL CELL PURCHASE**

Fuel Door Gasket....20327-003....Call for Information

PA30 Aux 19051-000.....Call for Information

462-021 Fuel Sender Gasket.....Call for Information

751-871 Fuel Screen Gasket.....Call for Information

462-014 Large Oval Cork.....Call for Information

22846-000 Fuel Filler PA30 Aux...Call for Information

20366-000 Black Oval (upper).....Call for Information

20366-002 Black Oval (lower)... Call for Information

All Prices Are Subject to Change Without Notice. Check with us for all your Comanche Needs.

06/05/25



1134 N. Oliver Road, Hgr G * Newton, Ks 67114 USA
 Ph. 316-283-7929 Fax 316-283-4702 Email: Sales@webcoaircraft.com

Gap Seal Kits

**FAA-STC'D
 BEST FIT
 EASIEST INSTALLATION
 BEST QUALITY
 EXCLUSIVE BAKED-ON TEFLON COATING
 ONLY \$680.00 Per Kit**

NACELLE FUEL TANK KITS

Mounts in center nacelle bay on each side.

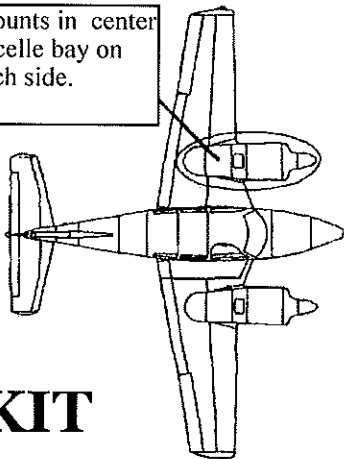

KIT

**FAA-STC'D
 FEATURES:
 EASY INSTALLATION
 10.2 GAL/SIDE, ALL USEABLE
 ALL ENCLOSED PLUMBING
 \$3500.00 COMPLETE**

Side Window Sets

**FAA-STC'D
 BEST FIT
 HIGHEST QUALITY
 EASIEST INSTALLATION
 BEST QUALITY
 BEST VALUE AVAILABLE
 PRICES START AT \$950.00 Per Set**

*All Prices Are Subject to Change Without Notice. Check with us for all your Comanche Needs.
 01/07/25*

ELECTRICAL COMPONENTS:

We stock most all Comanche Electrical Parts Including:

- Landing Light Bulbs
- Circuit Breakers
- Flap/Gear Switches
- Rheostats**
- Panel Switches
- Bulbs
- Cables
- Solenoids

GIVE US A CALL!

Electrical Misc.

Rotating Beacon
Assy - WRML-14R
SCALLS
Lens - 754-527
Bulb - 1940
\$13.60
WRM1940 \$26.95

Upper Console
21309-00
24705-00
26637-004
LENSES:
20635-002/003
20635-004
Call for Information
SPEAKER:
21879-000 - \$50.00 Ea.

Pilot Tube
Mast - 21299-000
Call for Information
Tube - 21301-000
Market Price

Lift Detector
450-742
Call
\$725.20

Gear Warning Horn
565-325
Call for Availability

Cable w/Bolt Positive
14069-000 \$83.70
Alt 66616-000 \$68.50

Clump
454-925
\$28.00
Tubing
\$4.00/Fl.

Starter Solenoids
487-149 - 602-850
All PA24/PA30 up to 1744
Pipe - \$128.50
487-163
PA30 1745 & UP \$68.75
Gear/Flap Solenoids
487-152 - 584-420
All Models
\$165.00
PMAVD Alternates \$115.00

Ground Cable
17604-029 - 180's
17604-016
400/250/260
Call

Nose Gear Switch
487-820
NOSE GEAR DOWNLOCK
180/250/400 PA30 up to 694
\$185.00 Ea.
487-862
NOSE GEAR DOWNLOCK
ALL 260 - PA30 695 & UP
\$525.00 Ea.

Tail Nav Light
Bulb
GE93 - 180/250
\$3.00
GE1073 - 260/400/30
\$3.50
LENS - 751-203
\$42.85

Master Solenoid
455-342
All PA24
\$365.50 Ea.
455-151
PA30/39
\$350.00
PMAVD Alternates \$115.00

Battery Cable Kits
Mil Spec #2 Gauge Copper
180/250 solenoid top pilot
\$310.00
180/250/260 solenoid bottom co-pilot
\$210.00
260B - \$155.50
260C - \$192.50
PA30 (Front/Rear Battery)
250.00

Gear Switch
487-820
SAFETY/SQUAT - 180/250/400 PA30 up to 694
L&R DOWNLOCK - 180/250/400 PA30 up to 694
\$185.00 Ea.
487-864
L&R DOWNLOCK/SAFETY/SQUAT - 260 ALL
RH DOWNLOCK ONLY - PA30 695 & UP
\$725.50 Ea.
487-863
LH DOWNLOCK/SAFETY/SQUAT - PA30 695/UP
\$795.80 Ea.

Ignition Switch
756-115
14314-002
180 1-2298/250 1-2201
\$525.50 Ea.
All Other PA24
\$648.50 Ea.
Alternate \$115.00*
Call for details

Guard Bracket/Actuator
17807-000
Call for Information
Boot
10PA1
\$38.50 Ea.
Boot Assy 1PA1S
\$30.00
Bracket/Actuator
MCD271H
\$115.50 Ea. SERV.

01/26/26



All Prices Are Subject to Change Without Notice

Nacelle Tanks

FEATURING:

Easy Installation, approximately 35-40 hours.
Economically priced at \$3500.00 for Complete kit & STC.
10.2 gallons per side, all useable.
All enclosed, no external plumbing except vent,
drain & overflow tubing ends.

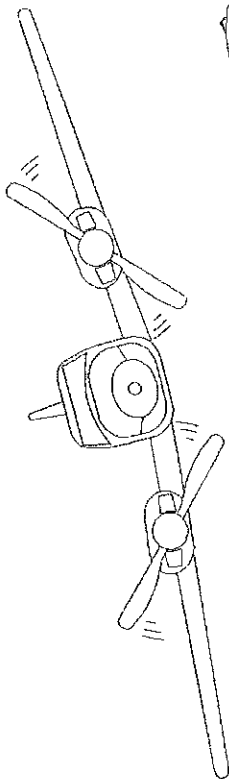

Mounts in center nacelle bay on each side.

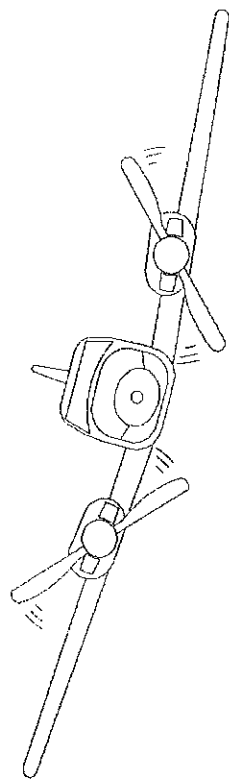
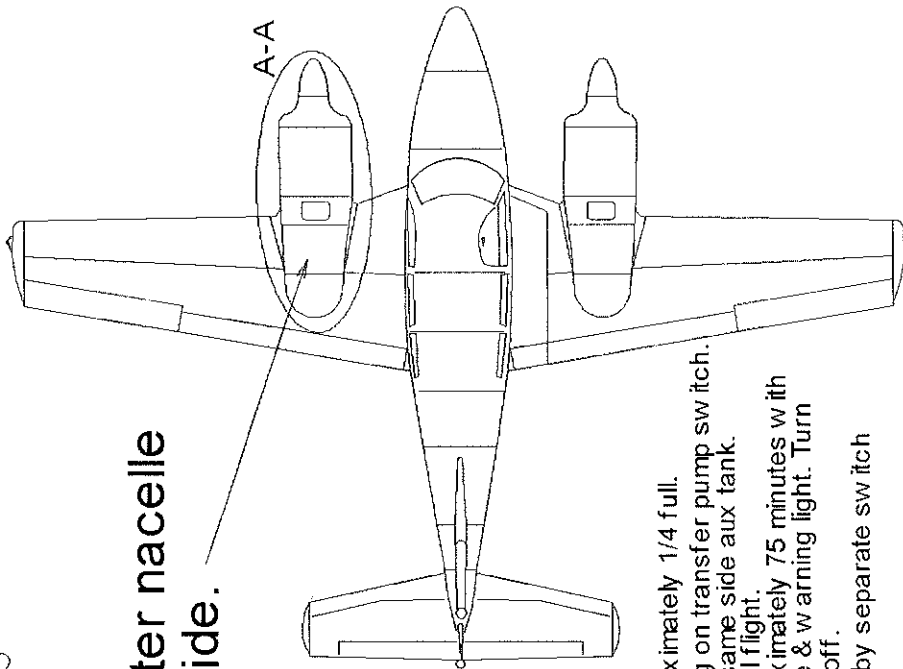

VIEW A-A
LH side shown with center nacelle skin removed.

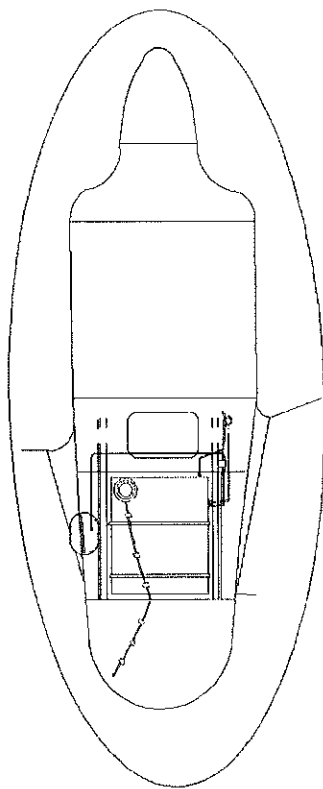

Operation Procedure:

1. Burn aux tanks to approximately 1/4 full.
2. Begin transfer by turning on transfer pump switch.
Fuel is transferred into same side aux tank.
Transfer must be in level flight.
3. Transfer will take approximately 75 minutes with completion noted by time & warning light. Turn nacelle transfer switch off.

Note: Each side controlled by separate switch and lights.

FULLY STC'D & PMA'D!
YOUR MECHANIC CAN INSTALL.

APPLICATION:
Piper PA30/39, All SN.

Webco
ircraft



01/09/25

All Prices Are Subject to Change Without Notice

PA30 Engine Misc.

NON-TURBO
460-630 Orig.
\$Aval? PMA \$68.50
BA105 Assy \$45.85 Ea.
BA10 Element \$36.00 Ea.

TURBO
201485 Orig.
\$198.50 Ea
BA121 Assy \$50.95 Ea
BA27 Element \$25.50 Ea

Air Filter

NOW AVAILABLE
Alternate Air Box
23810-000 Assy
\$850.00 Max. Repair
(\$75.00 Core Charge)
Components
23809-010 Door Assy
Call for Availability
Hinge/Spring
Call for Availability
23809-004 Door Seal
Call for Availability
23995-000 Bellcrank/Cam
Call for Availability
W25246-000 Bracket
\$45.00 Ea.

Oil Cooler Replacement
18622-000
\$564.00 Ea.

Hanger/Strap
W25973-000
\$43.50 Ea.
Attach Clamp
80002-076
Call for Availability

Baffle Tie Rod
10487-006
Call for Availability

Breather Tube
23845-000
Call

Non-Turbo Air Filter Box
23883-000
Call for information
Air Filter Box Lid
23886-000
Call for information
Repairs Offered

Tach Reverser
451-900
\$240.00 Ea.
(C/R Engines only)

Oil Cooler Hose Set
W-OC4
Call for Pricing

Exhaust Stack
23850-008 RH Front
23850-010 LH Front
23850-011 RH Rear
23850-012 LH Rear
P.O.R.
(+ \$100.00 Core Charge on each)

Pre-Cut Baffle Rubber
WBF30NT
Non Turbo - \$49.50
WBAF30TB
Turbo - \$63.25
We now carry the metal baffle parts from Airforms

Spinner Composite
Lifetime Warranty
23818-000 Comp
Call
23818-000 Piper
Original Aluminum
\$1900.00/Call
23819-000 DOME
\$65.00

Spinner Bulkhead
W23815-000
\$324.50 Ea.
W26313-000
(Heavy Duty & 260C)
\$378.50 Ea.

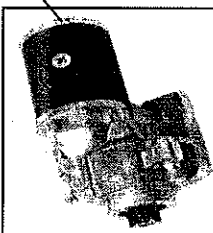

B&C Lightweight Starter
10.2 Lbs
Best Quality Available
No Bendix Problems
\$1035.00
C/R also available

11/21/25
*Prices Subject to Change

Wabco Aircraft
Comanche Specialists

All Prices Are Subject to Change Without Notice

PA30 Turbo Misc.

**Turbo Inlet Scoop
RJ0617-3
Call for Info**

**Duct Hose
RJ9502-20-22-6A
\$70.40 Ea.**

**Grommet
RG56W
\$3.00**

**Duct Hose
RJ9503-18-19
\$60.00**

**Duct Hose
RJ0632
\$156.85**

**Gasket
RJ0115
\$30.80**

**Turbo Air Filter
201485 Original
\$198.50 Ea.
Brackett Brand
BA121 Assy – \$50.95
BA27 Element – \$25.50**

**Clamp
RJ0193
\$400.00**

**Duct Hose
RJ9504-28-15
\$155.00**

**Gasket
RJ0114
\$30.80**



11/21/25

All Prices Are Subject to Change Without Notice

Interior Misc.

PA24 - Later

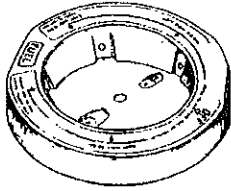

Dish w/o decal - \$37.75
Decal - \$14.50

PA30 - w/o Tips

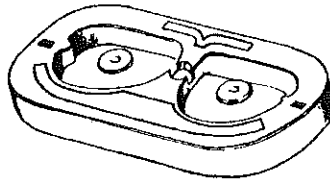

Dish w/o decal - \$35.75
Decal - \$15.00

PA24 - Early

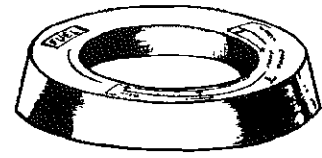

Dish w/o decal - \$35.75
Decal - \$13.75



24741 Plate - \$16.50
21154 Scoop - \$16.50

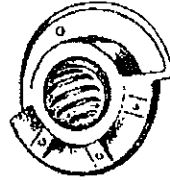

26441 Plate - \$17.50
25593 Louver - \$16.50



24741 Plate - \$16.50
24738 Scoop - \$16.50

Wing Tip Misc.

Reflector
20587-002-LH
20587-002-RH
Call for Info

Lens
751-201 RH
(green)
\$88.90
751-202 LH
(red)
\$78.80

Bulb
751-381
(1512)
\$28.85

Mirror
(Gear Check)
WTM1-LH
WTM1-RH
\$22.55

Mirror Only
(PA30 Nacelle)
\$4.25
No Cert on parts

Bulbs
GE 4509
\$19.85
GE Q4509
* \$38.50
Alt \$20.00
PAR36 LED
Bulbs
Start at \$325.00
Aero Lite
Alternate \$82.85

Lens
W20348-00 LH
W20348-00 RH
\$43.50
Made from Lexan

Trim Seal
19795-000
(8301)
\$2.25/ft

A Good Value

* The "Q" 4509 bulbs are the best deal. Compare specs:
4509 - 100 watts, 25 hours, 110,000 Candlepower
Q4509 - 100 watts, 100 hours, 140,000 Candlepower
(Brighter, Lasts 3x longer, uses same amount of watts)

11/21/25



All Prices Are Subject to Change Without Notice

Now Stocking: Bogert Battery Boxes, Tow Bars and Bungee Cord Installation Tools

Bogi-Bar Vehicle Tow-Bars
 \$225.00 Ea

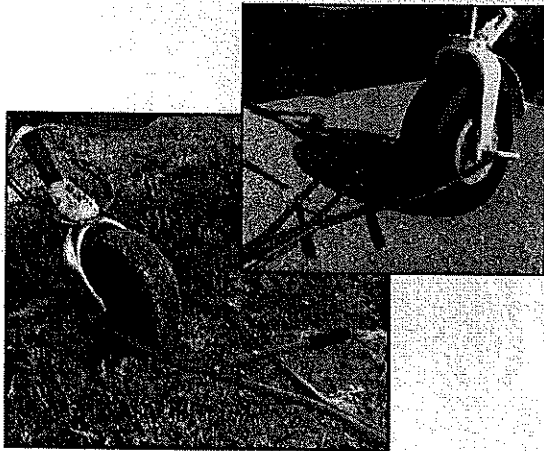

**STC'd Replacement
 Battery Boxes**

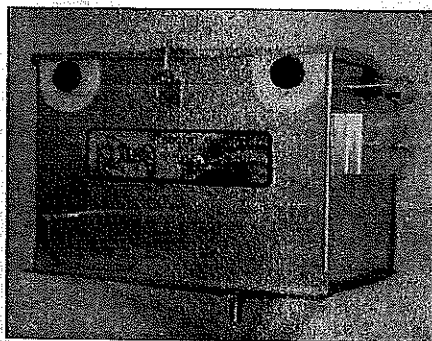

Replaces Both
 Plastic & Metal
 Piper Boxes
 STC'd
 For many Models

Bungee Cord Install Tool
 \$217.00 Ea

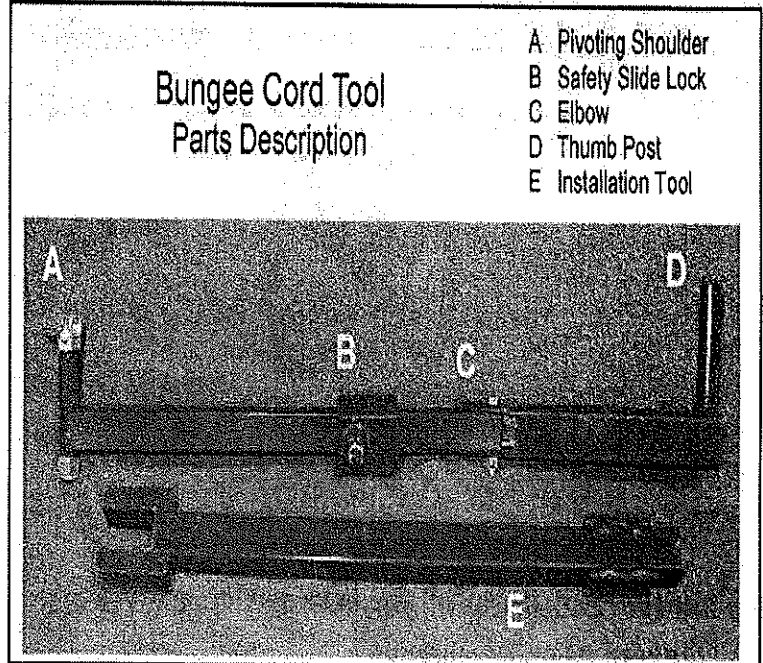

**Call for Current
 Pricing &
 Availability**

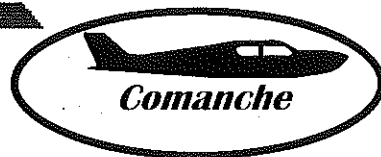

1134 N. Oliver Road, Hgr G * Newton, Ks 67114 USA

*Check out the Door Steward,
an STC'd affordable replacement for your door holding woes.*

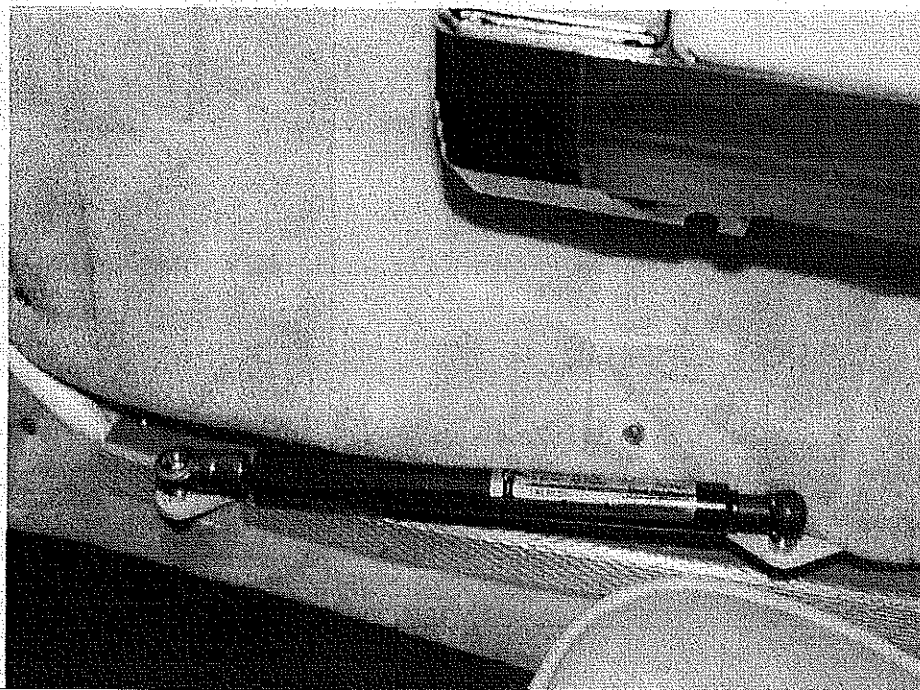
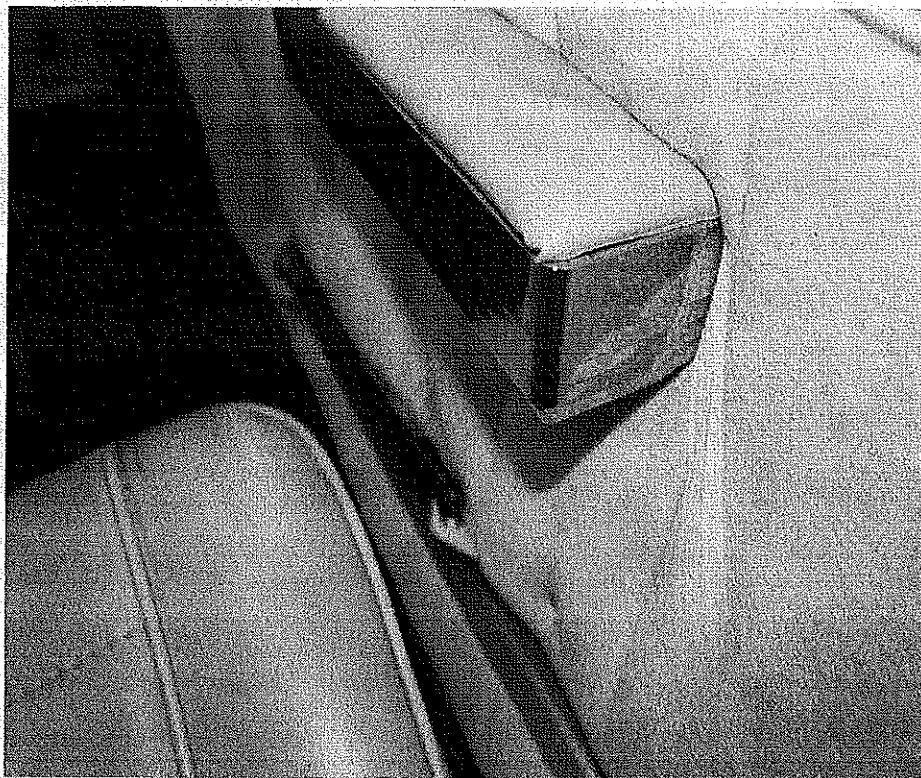

Only \$276.00 complete.

** All Prices Subject to Change Without Notice.*

STC'd Alternator Conversion Kits For Single and Twin Engines

Single Engine \$1875.00

SKU# SAL12-70

Description: 12/14 volt, 70 amp*, replaces generators
On many Piper and Mooney aircraft with Lycoming
Engines.

Warranty: 2-Year Limited

Alternator Weight: 10 Pounds

Price: \$749.00

*Aircraft electrical system will be limited by existing wiring and
Output breaker. The Plane-Power alternator can produce all 70
amps if proper size wiring and circuit breaker is installed.

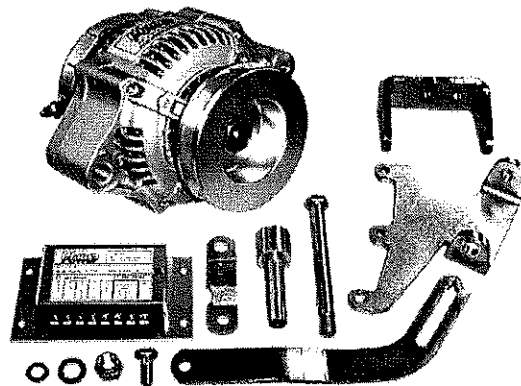

Twin Engine \$3628.00

SKU# TAL12-70

Description: 12/14 volt, 70 amp*
Alternator kit, replaces generators on
many twin-engine Piper aircraft with
Lycoming engines.

Warranty: 2-Year Limited

Alternator Weight: 10 Pounds

Price: \$1499.00

*Aircraft electrical system will be lim-
ited by existing wiring and output
Breaker. The Plane-Power alternator can
produce all 70 amps if proper size
Wiring and circuit breaker is installed.

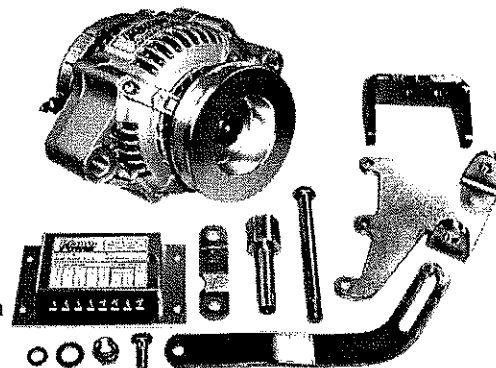
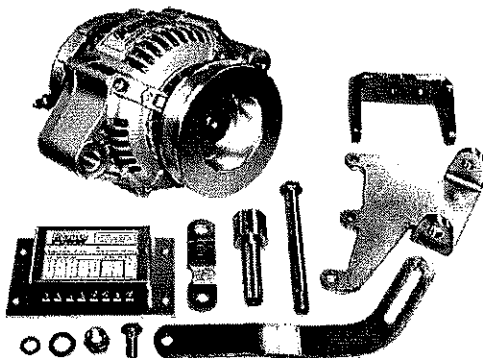

Now
Selling

PIPER "GOLD"

FIT ALL PIPER AIRCRAFT MODELS & TYPES
GOLD TINI SPUTTERED OR SATIN BUFFED
STAINLESS STEEL ANGLED RINGS & SKID
SAFE TO 230+ MPH FRONT OR SIDE GROUND WIND

OVER 1000 SETS SOLD!

Rings and Skid Fit All PIPER Aircraft Types-



GOLD TINI SPUTTERED ANGLED RINGS \$236/EA



GOLD TINI SPUTTERED SKID & STRIKEPLATE \$236/EA

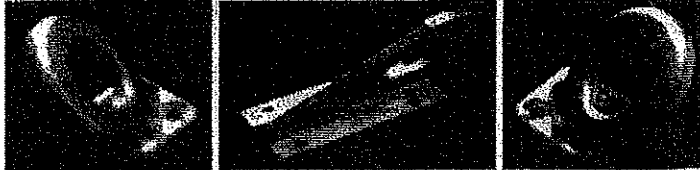

SATIN STAINLESS STEEL RINGS & SKID-5198/EA
Also, Ni Plated or White Rings & Skid-S198/EA
FREE SHIPPING & SCREWS +(Great Fuel Ground)

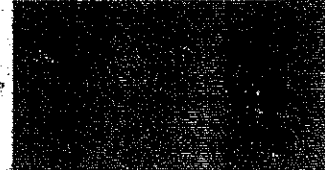



1134 N. Oliver Road, Hgr G * Newton, Ks 67114 USA

NOW AVAILABLE!!!

From Matt Kurke at Comanche Gear two of his publications. Landing Gear Push/Pull Cables Manual and 1000 Hour Gear Inspection Manual.

Comanche

**Landing Gear
Push/Pull Cables
Installation and
Adjustments Manual**

COPYRIGHT © 2024
Webco Aircraft, LLC. All Rights Reserved

Made with pride by:



Parts and Other Stuff for

Matt Kurke, A&P, ICS, BSME PHON

Comanche

1000-hour gear inspection:

**Taking the Mystery out of
AD 77.13.21, Part A
for Singles and Twins**

COPYRIGHT © 2024
Webco Aircraft, LLC. All Rights Reserved

Made with pride by:



Parts and Other Stuff for your Comanche

Matt Kurke, A&P, ICS, BSME PHONE 316-283-7929
webcoaircraft .com

Landing Gear Push/Pull Handbook — \$30.00

1000 Hour Handbook— \$65.00

* All Prices Subject to Change Without Notice.